



THE PEELLE COMPANY

FREIGHT DOORS | CAR GATES | CAR ENCLOSURES

GUIDE 226



LIGHT CURTAIN INSTALLATION GUIDE

4697 & 4698 Series

VSD | VERTICALLY
SLIDING
DOORS

04/23/2014 - V1

IMPORTANT INFORMATION

FOLLOW THE INSTRUCTIONS GIVEN IN THIS MANUAL CAREFULLY. FAILURE TO DO SO MAY CAUSE CUSTOMER COMPLAINTS, INJURY, AND / OR SERIOUS CALL BACKS. KEEP INSTRUCTION MANUAL ON SITE.

DO NOT USE THIS PRODUCT IN EXPLOSIVE ATMOSPHERES, RADIOACTIVE ENVIRONMENTS OR FOR MEDICAL APPLICATIONS! USE ONLY SPECIFIC AND APPROVED DEVICES FOR SUCH APPLICATIONS OTHERWISE SERIOUS INJURY OR DEATH OR DAMAGE TO PROPERTY MAY OCCUR!

THIS DEVICE MUST NOT BE USED AS A PROTECTIVE DEVICE FOR DANGEROUS MACHINERY NOR IN EXPLOSIVE ATMOSPHERES OR RADIOACTIVE ENVIRONMENTS

IT IS IN THE SOLE RESPONSIBILITY OF THE PLANNER AND/OR INSTALLER AND/OR BUYER THAT THIS PRODUCT IS USED ACCORDING TO ALL APPLICABLE CODES AND STANDARDS IN ORDER TO ENSURE SAFE OPERATION OF THE WHOLE APPLICATION.

ANY CHANGE OF THE DEVICE BY THE BUYER OR USER MAY RESULT IN AN UNSAFE CONDITION.

PEELLE DENIES EVERY LIABILITY AS WELL AS WARRANTY CLAIMS WHICH RESULT FROM SUCH MANIPULATION.

CAUTION!

THE LIGHT CURTAIN IS DESIGNED TO DETECT PASSENGERS AND FREIGHT OF A SPECIFIC SIZE

OBJECTS SMALLER THAN THE SPACING BETWEEN THE LIGHT BEAMS MAY NOT BE DETECTED. TRANSPARENT OBJECTS MAY NOT BE DETECTED.

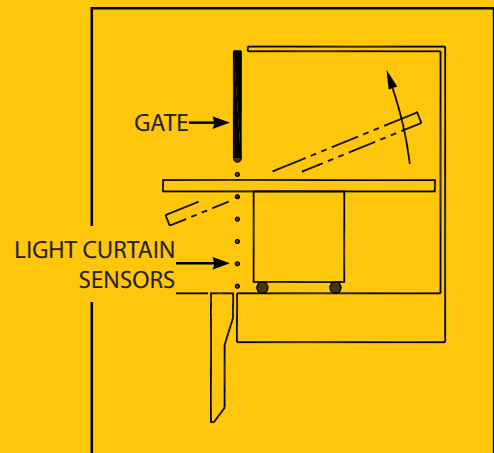

AVOID IMPROPER USE



THE PEELLE COMPANY

FREIGHT DOORS | CAR GATES | CAR ENCLOSURES

TECHNICAL SUPPORT 1-800-787-5020 ext 275

Introduction

The light curtain is an optoelectronics sensor. A number of infrared beams, emitted by an emitter edge and received by a receiver edge, separated by a given distance, form a grid that is called a light curtain. If all infrared beams are free (not interrupted), an output signal is activated, e.g. to allow an industrial gate to close. However, if one or more beams are interrupted, the output signal is inactivated in order to prevent the gate from closing or to reopen the gate during closing.

The safety light curtain Light curtain is especially designed to avoid a collision between a closing vertical car gate and an object that is in the closing area of the gate. Due to its extremely compact design, it is possible to install the light curtain edges near the guide profile of the car gate itself. The wide operating range provides a lot of freedom for many applications with automatic vertical car gates.

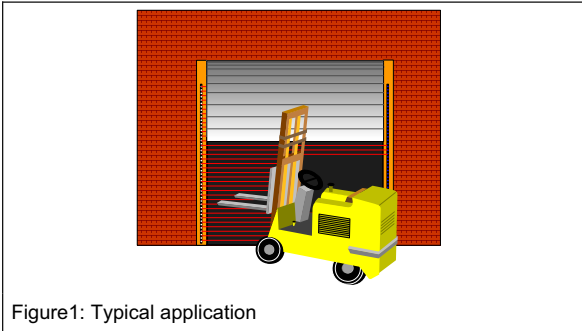

Figure 1: Typical application

Features

- Extremely dense protective field
- Installed near the guide rails
- Wide operating range
- Robust and reliable
- Sophisticated ASIC technology
- Simple mounting
- Detachable cables
- Virtually no alignment necessary
- Wide power supply range 17 ... 240 VDC
- Test input 24 VDC
- All gold-plated contacts, PCBs and connectors

Buzzer

The control unit has a buzzer that is active when one or more beams are interrupted. The buzzer can be switched on and off with the slide switch located between the connectors of the sensor edges.

It is very useful to verify the installation with a turned-on buzzer

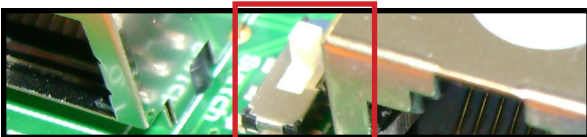

Block diagram

The Figure 2 shows the block diagram of the light curtain. As indicated, it consists of an emitter and a receiver edge that are connected with detachable cables to the control unit.

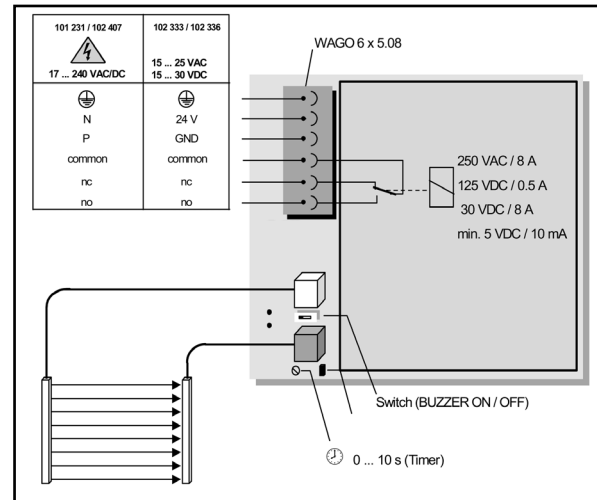

FIGURE 2 BLOCK DIAGRAM

The control unit contains the power supply and the logic that manages the sensor edges. A relay provides the status output of the light curtain grid to the car gate control unit. In the following sections, the individual elements of the whole device are described in detail.

Input supply voltage

The light curtain has a unique universal power supply that operates within an input voltage range between 17 to 240 Volt AC or DC. No adjustment is necessary. The power supply automatically detects the voltage and adjusts itself for proper function.

Output relay

The output relay provides that status of the light grid to the gate or door drive control unit.

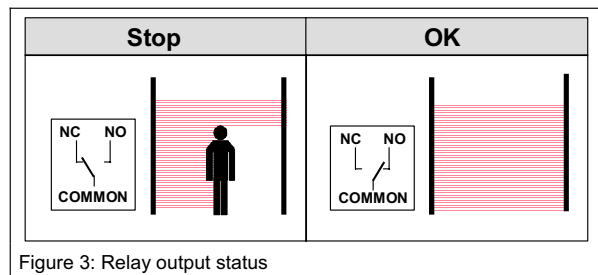

Figure 3: Relay output status

Inactive mode

The protective function may be deactivated i.e. for servicing elevator cars. To deactivate move hand slowly from top towards bottom. The light curtain remains deactivated for appr. 10 seconds and the buzzer beeps.



THE PEELLE COMPANY

FREIGHT DOORS | CAR GATES | CAR ENCLOSURES
TECHNICAL SUPPORT 1-800-787-5020 ext 275

Installation (Breakdown)

1. Fasten the sensor edges with 3 screws to a flat wall or near the guide tracks. The lenses of the sensor edges (black points) must face each other.
2. Mount the control unit with 2 or 4 screws to a stable location near the emitter edge.
3. Connect the cables from the sensor edges to the control unit. Guide and fix them properly and separate them, as far as possible, from cables that carry high voltages and/or high currents in order to minimize possible EMI interferences.
4. Connect the control unit to the gate/door drive unit (Relay Output, Test Input).
5. Connect the protective ground terminal of the control unit with a low impedance cable of AWG 15 / 1.5 mm² or thicker and a maximum length of 200 mm to a protective grounded frame or a protective ground socket.
6. Connect power to the control unit. The device indicates that it is receiving power by switching-on the green LED (power). When all light beams are free and the test input is on "high", the output relay changes to the state "OK" (relay output NO) and the yellow LED goes out.

If there are different LED readings than stated in paragraph 6, please go to the trouble-shooting section.

Assembly Notes

- The cable outlets of the sensor edges must be at the top, as the gate/door must enter the protective area from the top.

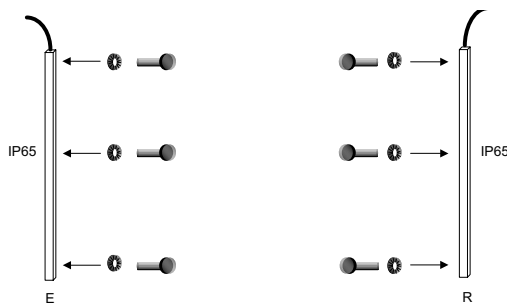

- ensure light curtain edges are securely fastened
- the cable is well fastened and routed
- avoid obstruction from door wings, cables etc. in the protective area

- The sensor edges must not be bent or be exposed to tension.

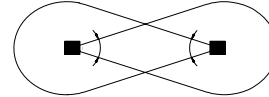

- The sensor edges have to be aligned better than $\pm 10^\circ$.



- The cables shall not be stretched or squeezed.
- Ensure a cable radius $R > 80$ mm and avoid contamination by oil or greasy liquids.

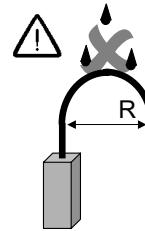

- Please note that the light curtain is an optical device. Therefore, avoid dust and dirt on the lenses.
- Other infrared light sources like optoelectronic sensors, flashlights, direct sun light, etc. shall not shine directly into the receiver edge. They can interfere with the light curtain and may lead to instable function. In such a case, please swap the emitter and the receiver edge, as the emitter edge is not sensitive to optical disturbance.
- Fix the control unit with 2 or 4 screws in order to avoid vibration.
- Close the cover of the control unit in order to avoid dust, dirt, humidity, and liquids on the electronic circuits and to avoid electrical hazards.

Connect terminal protective earth PE with low impedance ($< 10 \Omega$) to protective earth of the power supply.

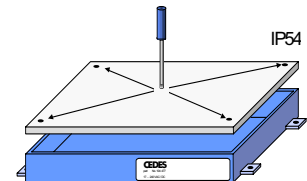

Danger of high voltage!

Disconnect power before opening the cover of the control unit!



THE PEELLE COMPANY

FREIGHT DOORS | CAR GATES | CAR ENCLOSURES
TECHNICAL SUPPORT 1-800-787-5020 ext 275

Installation

Sensor Edge Mounting

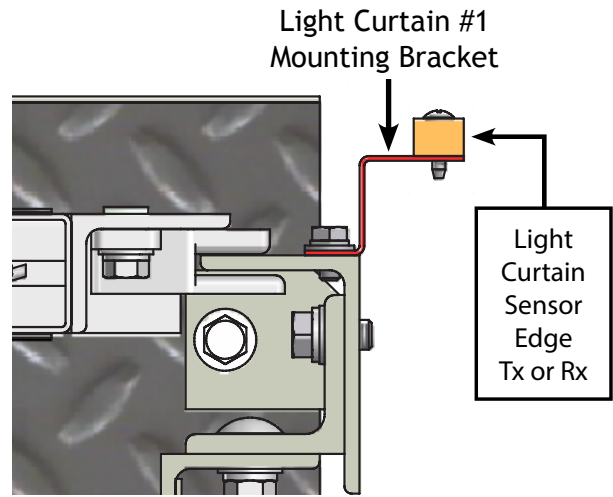

PLAN VIEW
Peelle single section car gate, right hand rail

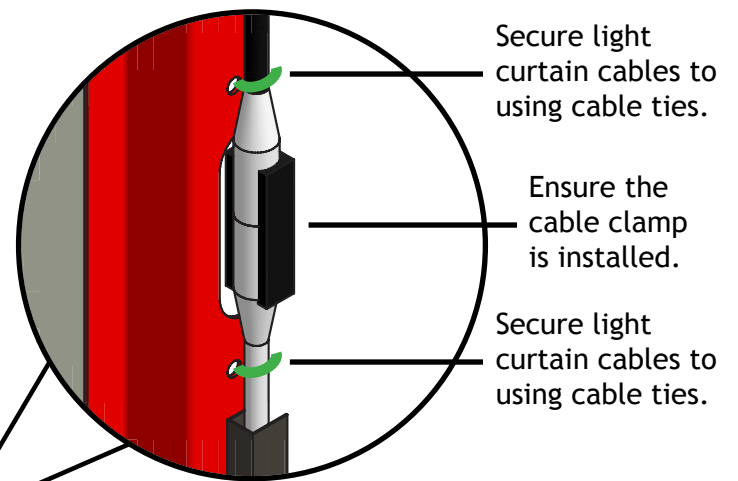
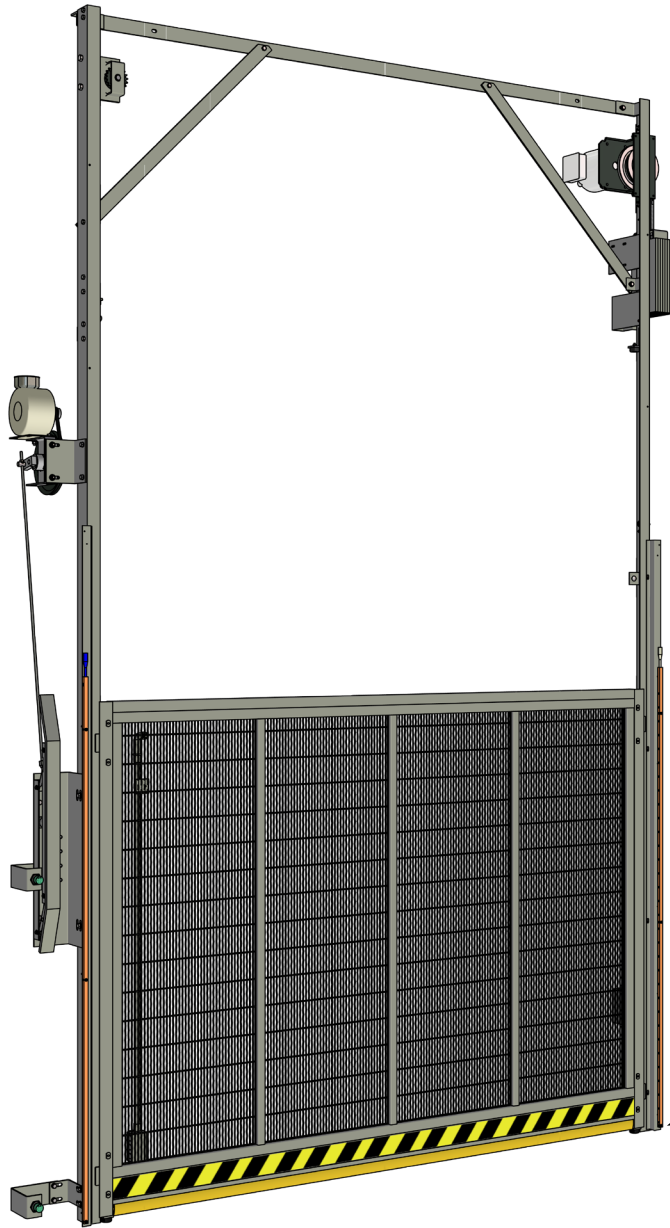

Light Curtain #1 Mounting Bracket

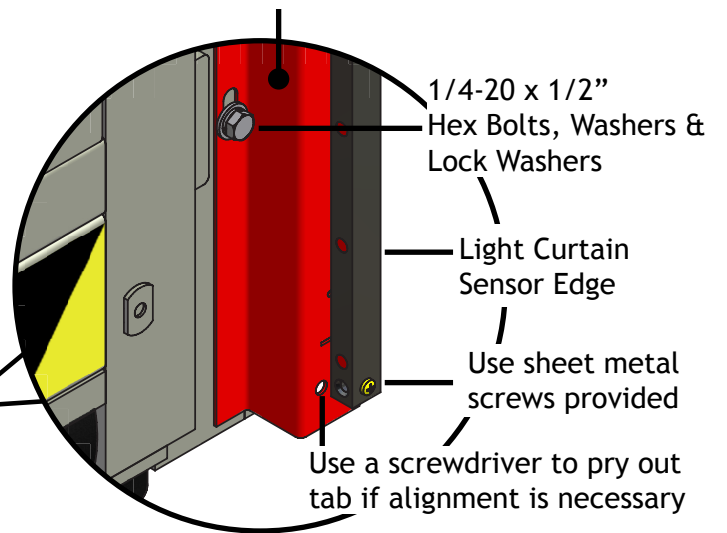

Installation - New Installation (Peelle Car Gates and PLC)

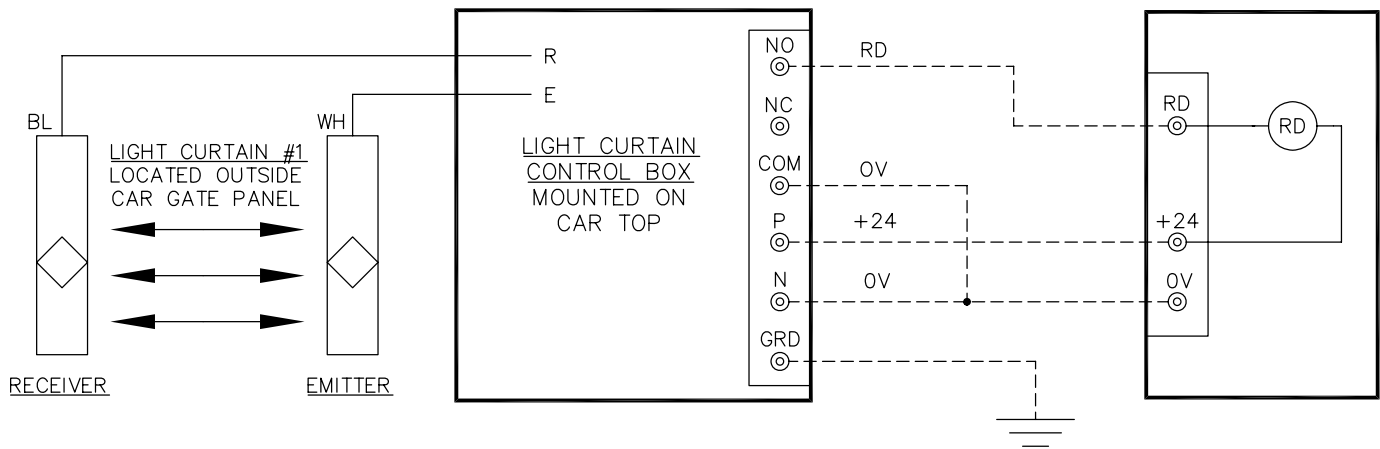

NOTES AND EXCEPTIONS:

1. Code compliance is the responsibility of the installer.
2. For other control interfaces, please contact Peelle engineering for assistance.

Troubleshooting

Problem	Solution
Intermittent Reversal / No Function	Clean Light Curtain Lenses
	Check to ensure that the Cedes controller is properly grounded
	Check that the Light Curtain Connection Cables are not running beside High Voltage motor wires
	Check that the Plugs are securely fastened using the cable clamps provided. (Do Not tape plugs together)
	Check to ensure Receiver is not in direct sunlight. Swap the transmitter and receiver if the receiver is affected
	Check to ensure proper alignment. Please see line of site diagram on page 5.
Light Curtains Plugged in / No Reversal / No Closing	If Warning strobe lights are used in close proximity of receiver, relocate light or shield if possible.
	Verify that the +24 & RD wires are connected to the proper relay output contact. RD relay in Peelle controller must be on (no detection) and off for reversal.

Cleaning of the sensor edges

The edges shall be cleaned with a soft tissue and little soap water only. Any use of abrasive or inappropriate cleaning solvents may cause loss of range or may damage the device.



THE PEELLE COMPANY

FREIGHT DOORS | CAR GATES | CAR ENCLOSURES
TECHNICAL SUPPORT 1-800-787-5020 ext 275

Light Curtain Edges (pair) IP65 Standard

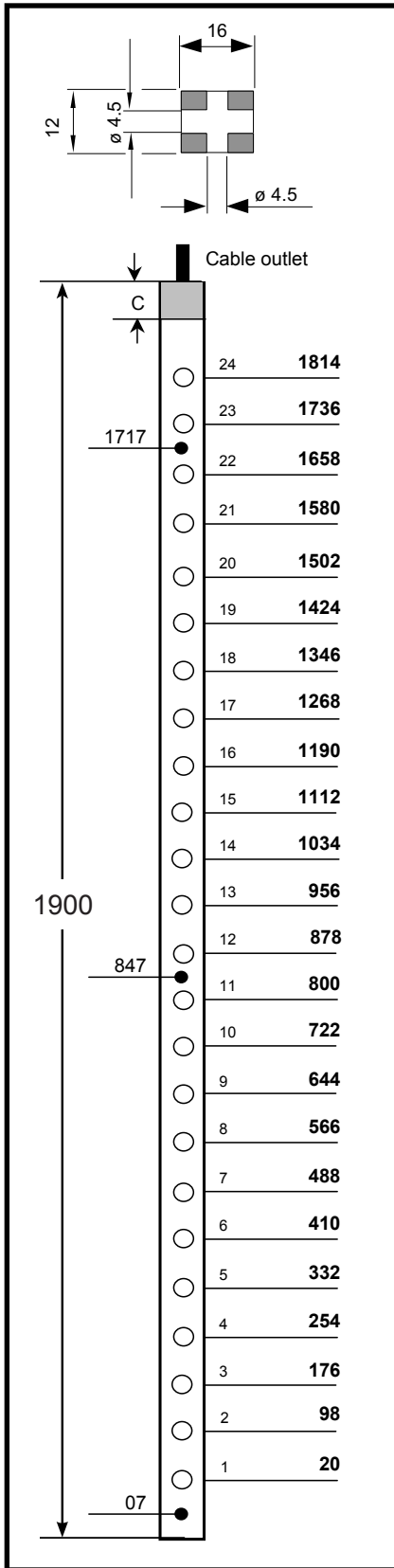

Parameter	Specification
Light Curtain NO TEST INPUT	4697 - NEMA1 (IP65) - 13 Ft Range With IP54 Control Unit
	4698 - NEMA1 (IP65) - 24 Ft Range With IP54 Control Unit
	4697M - NEMA4 (IP67) - 13 Ft Range With IP54 Control unit & IP67 moisture protection kit
	4698M - NEMA4 (IP67) - 24 Ft Range With IP54 Control unit & IP67 moisture protection kit
No. of light beams	24
Min. object size to be detected	78 mm at 1900 mm edge
Response time	max. 180 ms, typical 90 ms
Power supply voltage	17 ... 240 VAC / DC
Power consumption	6 VA 115 / 230 VAC, 130 mA / 24 VDC
Fuse	6.3 A (slow-to-blow, 250 V, measurement: 5 x 20 mm)
Relay output	250 VAC / 8 A, 30 VDC / 8 A (resistive load), min. 5 VDC / 10 mA
Temperature range	-20 ... +65°C
Vibration and shock resistance	IEC 68-2-6

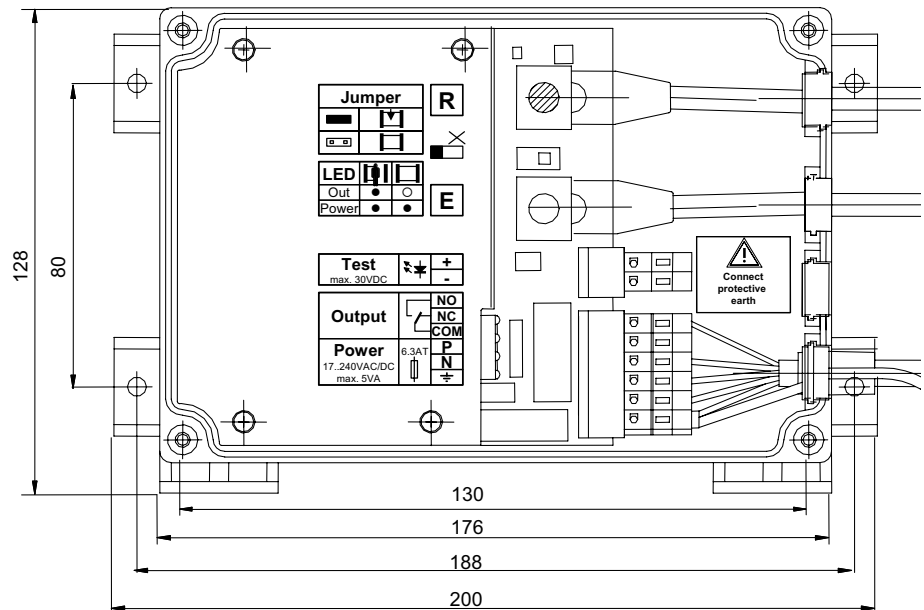

THE PEELLE COMPANY

FREIGHT DOORS | CAR GATES | CAR ENCLOSURES
TECHNICAL SUPPORT 1-800-787-5020 ext 275

Maintenance and Inspection

1. Doors and gates shall be maintained in accordance with Peelle Detail Installation and Maintenance Guide 215 Section 19.
2. Maintenance and inspection of the light curtains system shall be performed on a monthly basis. More frequent maintenance may be necessary where car gates are subject to demanding environments of dust, corrosion, moisture, grease, chemical or other conditions.
3. Where necessary, the elevator should be taken out of service for maintenance following proper procedures by trained maintenance personnel.
4. Refer to Guide 215 Section 19 for gate rail, panel and operating component maintenance.
5. Ensure that each light curtain edge is properly secured to the gate rail according to the installation instructions.
6. Ensure there is no debris affixed to the car gate panel or rails, for example plastic bags or other rubbish.
7. Check and clean the plastic lens filters on the edges to keep the system in optimum working condition.
8. Where provided, check the gate leading edge rubber astragal for wear or damage and replace if necessary. Make sure the astragal is properly seated in the holding extrusion.
9. Where pull straps have been provided for manual operation of power operated car gates, the pull strap should be removed to avoid interfering with the light curtain. If it is desirable to retain the pull strap, the strap shall be held in position above the leading edge of the car gate. An electric contact shall be provided that will break the contact, and prevent power operation of the car gate when the strap is removed from the held position for use. The contact shall be wired according to the car gate controller manual and wiring diagram.

Note to Maintenance:

The light curtain system represents an important safety device of the elevator and relies on integrity of all components. Should any part or function of the system be observed not to be in proper order, the elevator should be taken out of service until such time as the system is repaired.



THE PEELLE COMPANY

FREIGHT DOORS | CAR GATES | CAR ENCLOSURES
TECHNICAL SUPPORT 1-800-787-5020 ext 275



THE PEELLE COMPANY

FREIGHT DOORS | CAR GATES | CAR ENCLOSURES



TECHNICAL SUPPORT

1-800-787-5020 ext 275

NORTH AMERICAN SALES

sales@peelldoor.com

EXPORT SALES

exportsales@peelldoor.com

