

244-EN



CAR ENCLOSURE INSTALLATION MANUAL



THE PEELLE COMPANY

FREIGHT DOORS | CAR GATES | CAR ENCLOSURES

TECHNICAL SUPPORT 1-800-787-5020 ext 275

Guide No. 244-EN
CAR ENCLOSURE
INSTALLATION MANUAL

Date: Jan 26 / 2018

Contents

1. CAR ENCLOSURE ASSEMBLY.....	4
2. FLOOR ANGLES.....	5
3. WALL PANS.....	6
4. TOP ANGLES.....	7
5. TOP PANS & ENCLOSURE ANGLES.....	8
6. EMERGENCY EXIT & CONTACT.....	9
7. RAILINGS & BUMPERS.....	10



THE PEELLE COMPANY

FREIGHT DOORS | CAR GATES | CAR ENCLOSURES

TECHNICAL SUPPORT 1-800-787-5020 ext 275

Guide No. 244-EN
CAR ENCLOSURE
INSTALLATION MANUAL

Date: Jan 26 / 2018

1. CAR ENCLOSURE ASSEMBLY

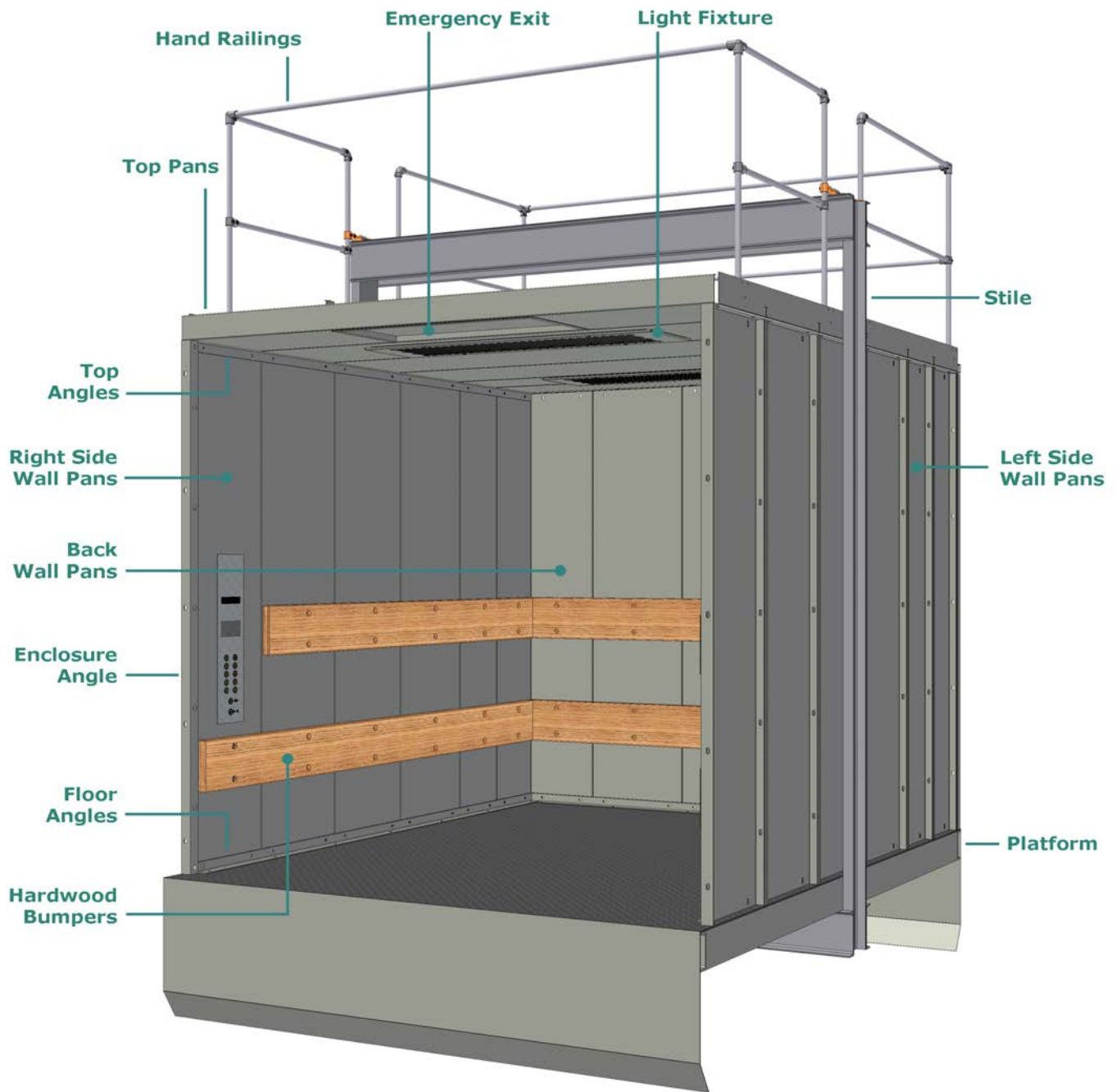

THE PELLE COMPANY

FREIGHT DOORS | CAR GATES | CAR ENCLOSURES
TECHNICAL SUPPORT 1-800-787-5020 ext 275

2. FLOOR ANGLES

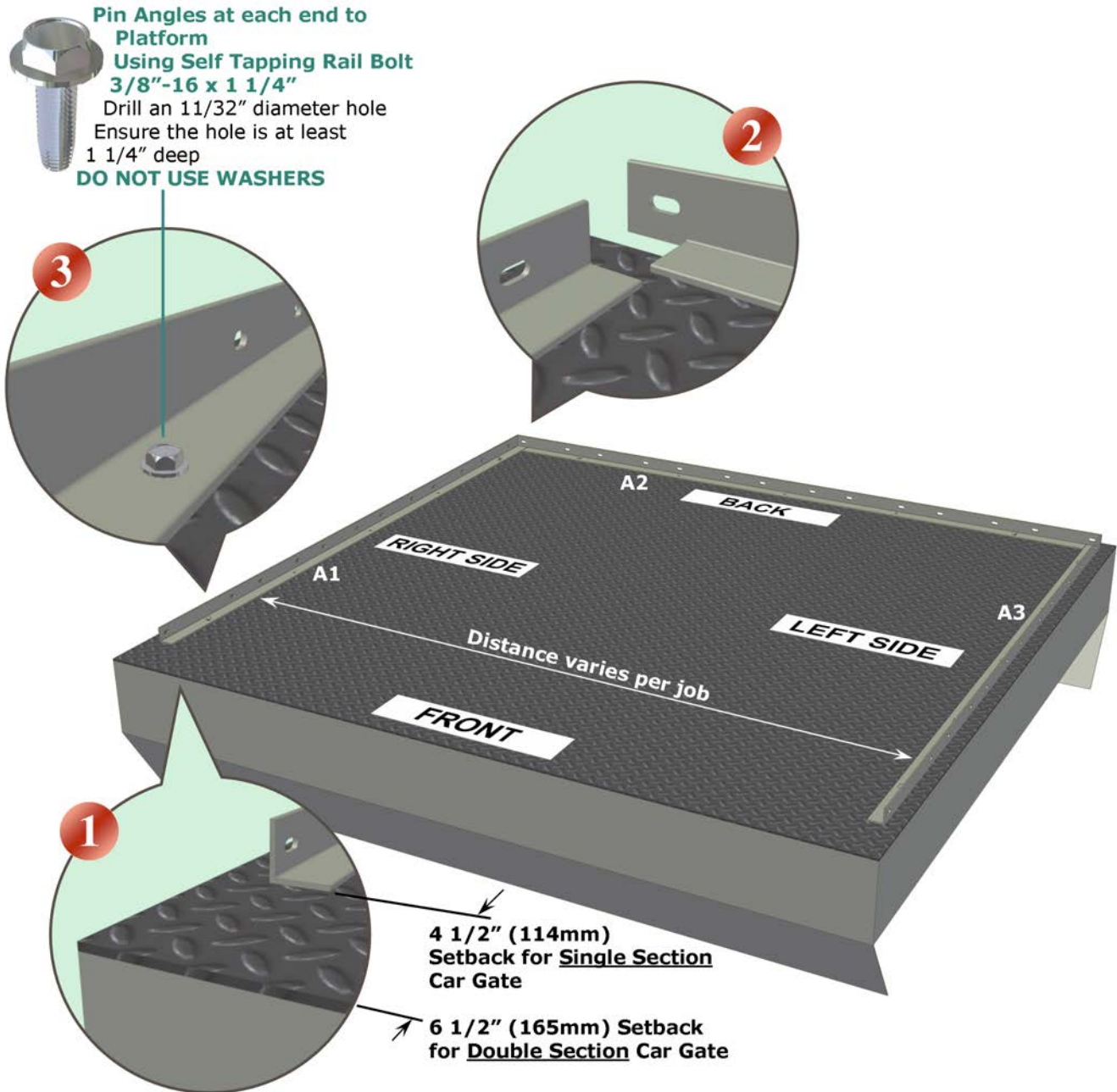

Note:
Refer to **FAST CAB** Assembly Drawing (-CE) for exact placement of floor angles.



THE PEELLE COMPANY

FREIGHT DOORS | CAR GATES | CAR ENCLOSURES
TECHNICAL SUPPORT 1-800-787-5020 ext 275

3. WALL PANS

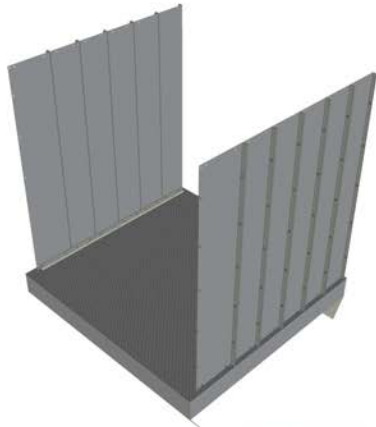

Double Opening FAST CAB
No back pans for this style of car.

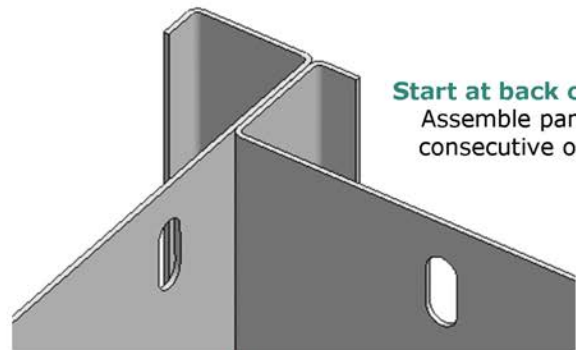

Start at back corner
Assemble pans in consecutive order

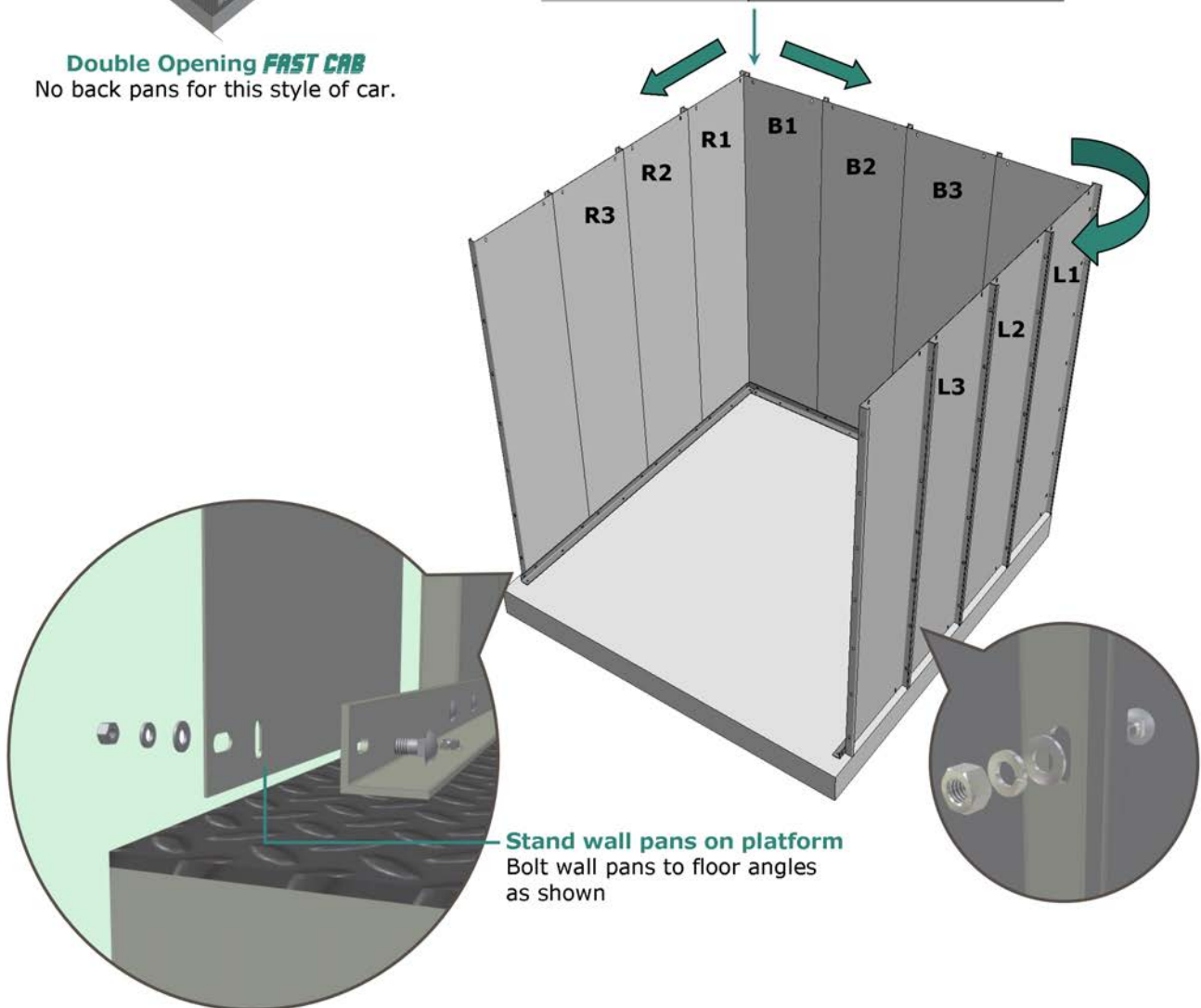

Stand wall pans on platform
Bolt wall pans to floor angles as shown



4. TOP ANGLES

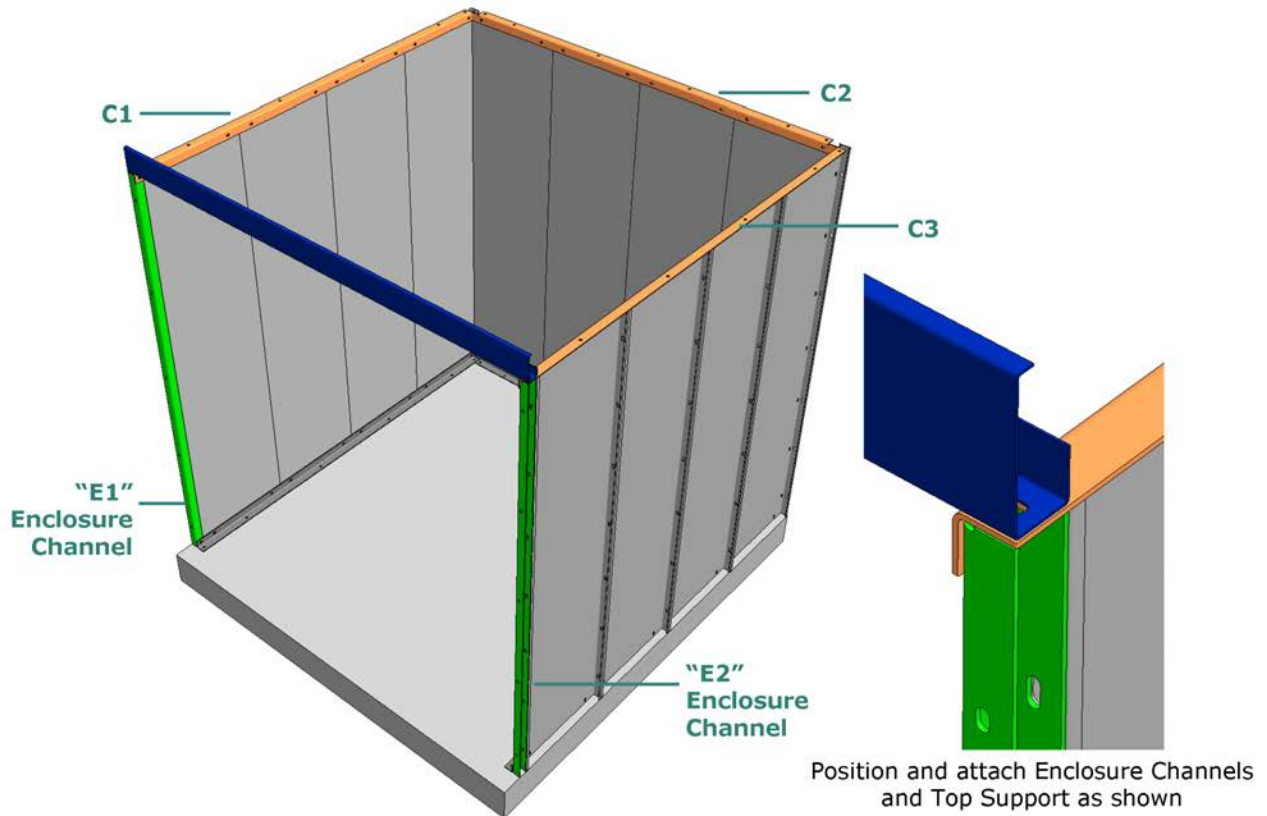
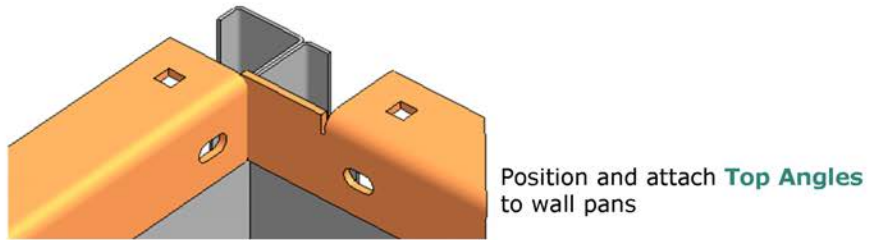

5. TOP PANS & ENCLOSURE ANGLES

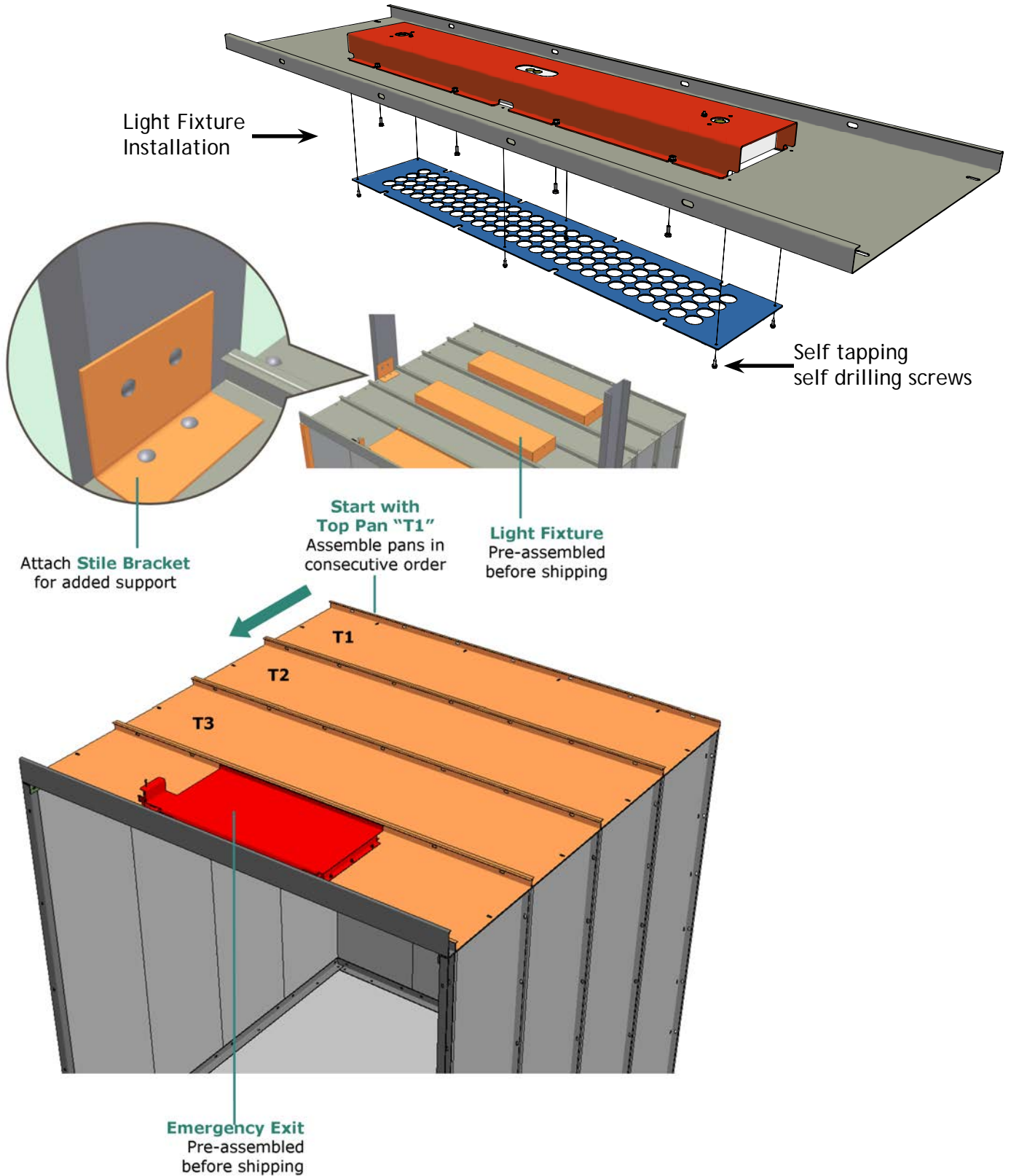

THE PEELLE COMPANY

FREIGHT DOORS | CAR GATES | CAR ENCLOSURES
TECHNICAL SUPPORT 1-800-787-5020 ext 275

6. EMERGENCY EXIT & CONTACT

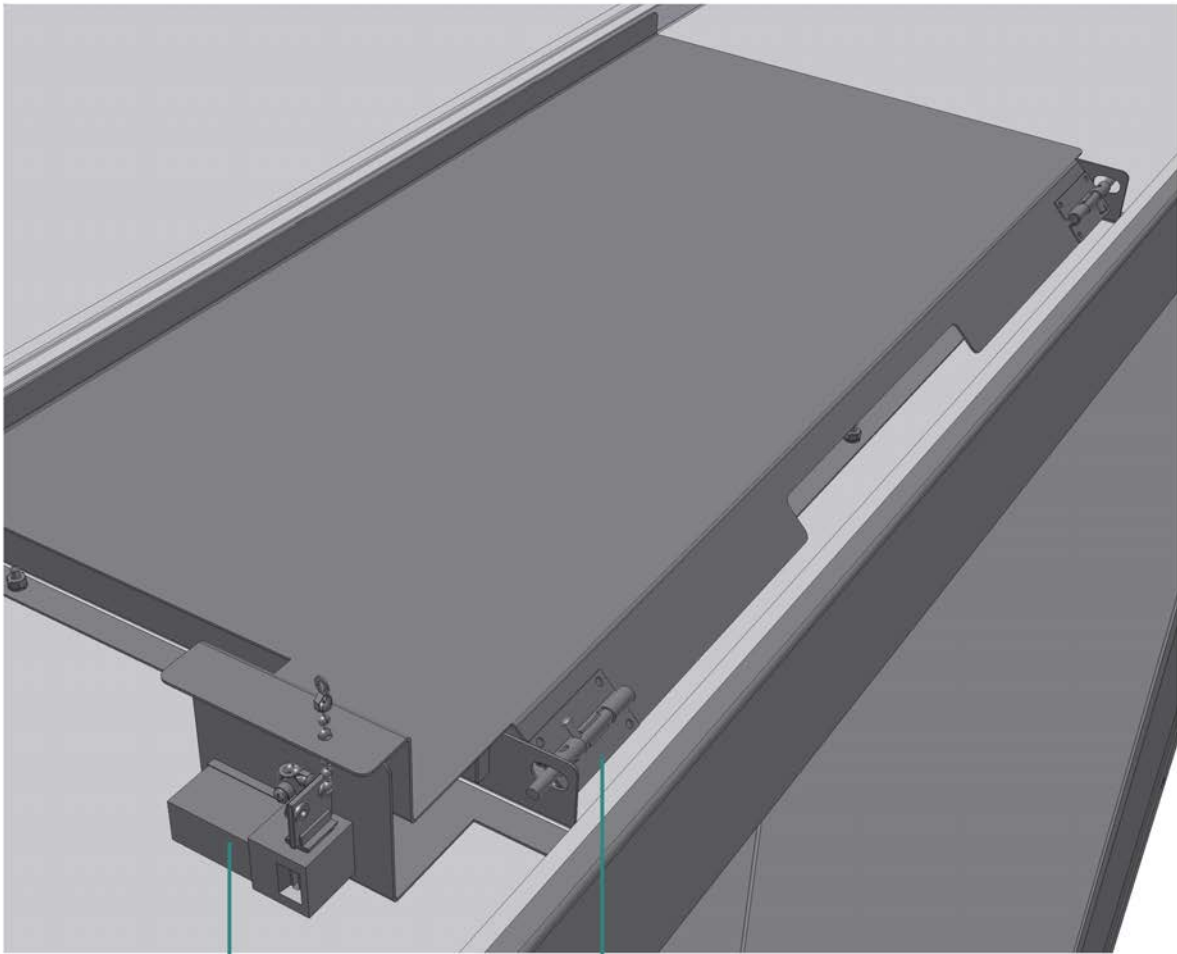

Exit Contact
Ensure contact is
assembled as shown

Slide Bolts
lock emergency exit cover in
closed position



THE PEELLE COMPANY
FREIGHT DOORS | CAR GATES | CAR ENCLOSURES
TECHNICAL SUPPORT 1-800-787-5020 ext 275

7. RAILINGS & BUMPERS

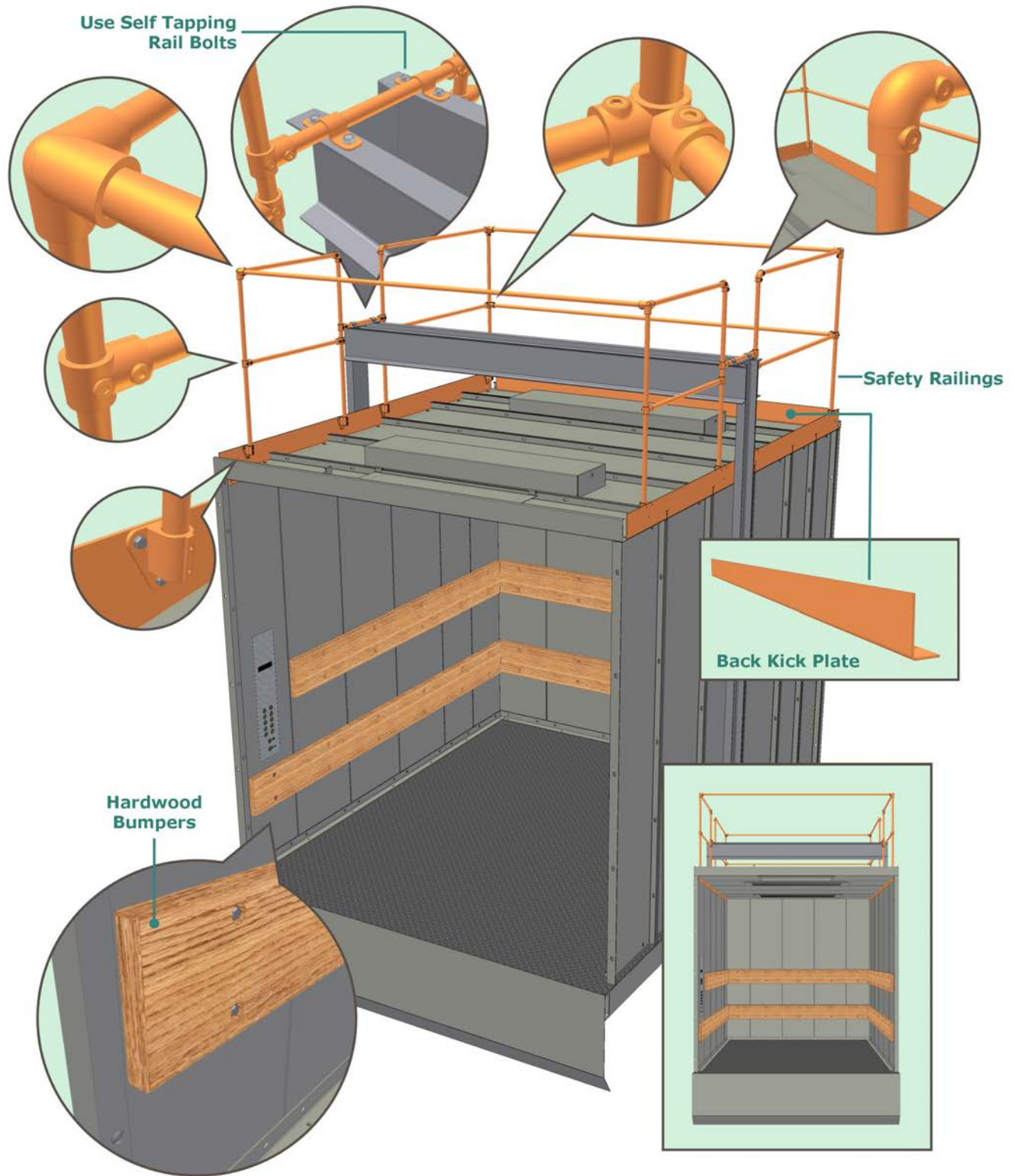

THE PEELLE COMPANY

FREIGHT DOORS | CAR GATES | CAR ENCLOSURES
TECHNICAL SUPPORT 1-800-787-5020 ext 275

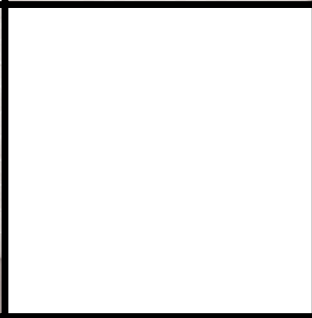

THE PEELLE COMPANY

FREIGHT DOORS | CAR GATES | CAR ENCLOSURES
TECHNICAL SUPPORT 1-800-787-5020 ext 275

Guide No. 244-EN
CAR ENCLOSURE
INSTALLATION MANUAL

Date: Jan 26 / 2018