

# FREIGHT ELEVATOR / GOODS LIFT NEW EQUIPMENT

306



**THE PEELLE COMPANY**  
34 E. Main Street, #372, Smithtown, NY 11787

**THE PEELLE COMPANY LTD**  
195 Sandalwood Parkway West, Brampton, ON L7A 1J6

REPRESENTATIVES IN GERMANY, FRANCE, MIDDLE EAST, SINGAPORE & THE UK

1 800 787 5020  
1 905 846 4545  
SALES@PEELLEDOR.COM  
PEELLEDOR.COM

APRIL 2020

# PEELLE® FREIGHT ELEVATOR DOORS

## Door Types – ISO Class IV

The two Peelle door types are *biparting* (counterbalanced) and *slide-up* (counterweighted), both of which slide vertically.

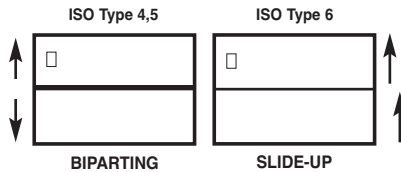

## Why Choose Peelle Doors?

**Experience:** Peelle is the most experienced manufacturer of biparting freight elevator doors in the world, incorporating in NY in 1905.

**Door Panel Construction:** Peelle provides the most robust door panel construction available on the market today. Each door panel is 12ga/ 2.5mm steel sheet construction. The panel includes a non-crushing meeting edge (Resilient Astragal), the lower panel of biparting doors includes a reinforced steel sill to support loading (Trucking Sill). Peelle doors are designed for long-term service taking loading abuse year after year.

**Door Design:** Due to the nature of large items loaded into good lifts, Peelle has developed extensive design capabilities; doors are designed for specific applications for openings up to 24 ft. /7,300mm wide, and loading capacity of 60,000 pounds/30,000 kg for biparting doors. Peelle manufactures biparting doors, two panel up-sliding doors and three panel up-sliding doors.

**Powder Coat Paint:** Door panels and components receive a baked-on power coat finish with Peelle standard RAL 7010 gray/green color. Many other standard and custom colors are available. Powder coat paint offers a hard coated finish similar to that found on other manufacturer's products exposed to the environment.

**Programmable Logic Controller:** Control system that provides all the necessary functions for automatic door operation. This controller interfaces easily with most elevator control system/manufacturers.

**Wireless Door Controller:** The wireless control system provides constant

Wireless Communication between all landing doors and car door (per line) creating a more reliable operation. The Control system also provides Closed Loop Feedback and true door positioning eliminating the need for limit switches and sensors. The Variable Voltage Variable Frequency Drive, utilizing the latest inverter technology and motor protection, is self learning – self adjusting which creates a smooth open and close sequence. It's also 100% Machine Room Less. An LCD Display provides on-board diagnostics displaying live status of all control system equipment. The controller comes ready for use, just plug in the door hardware and turn on the power, true Plug and Play.

**Light Curtain:** Each Peelle door system is furnished with a light curtain(s), providing protection of the opening. This light curtain eliminates potential contact with materials and personnel.

**Reputation:** The Peelle Company has been manufacturing vertically sliding doors for over a century and is still owned and managed by the Peelle family. Our reputation of high quality products and services is a Peelle priority; we are not happy until the customer is happy.

## Door Sizes

Peelle manufactures the largest available fire rated doors. Doors are manufactured to the specified size using durable hardware components. Doors are available with *widths* from 4 to 24 ft. (1200 to 7300mm). Doors are available with *heights* from 7 to 16 ft. (2100 to 5000mm) Biparting freight doors are manufactured to match any elevator capacity from 2,000 to 60,000 pounds (1,000 to 30,000 kg). A strong steel trucking sill, built into the lower panel, bridges the gap between the building and the elevator. Peelle doors allow large unrestricted openings and provide fire resistance and rugged durability. Larger sizes are available.

Peelle offers doors for installation in drywall as well as in masonry construction. Entrance Door frames, and frame installation details, are available; see page 16 and 17.

## Fire Rated Doors

Peelle offers labeled/certified fire-

rated doors in sizes up to 16 wide by 15 ft. high (5100mm wide by 4500mm high) and larger sizes when submitted to local authorities for inspection.

Doors have LPC (Loss Prevention Council) assessment for compliance to BS 476 part 22; Warrington fire assessment for sizes up to 20 ft. by 16 ft. (6m by 5m).

For drywall, fire-rated sizes may be up to 13 by 13 ft. (4000 by 4000mm). For complete stainless doors, fire-rated sizes may be up to 10 by 10 ft. (3200 by 3200mm).

## Approvals

Peelle products meet door performance standards for most countries. Peelle satisfies performance specifications of Underwriters Laboratories (UL/ULC) and Canadian Standards Association (CSA). Contact us for BSI (British Standards Institute), LPC (Loss Prevention Council), Warrington, EN81, and other approvals, such as local authorities in Singapore, etc.

## Door Components

A freight elevator landing door assembly includes the door panels, door guide rails, interlock door locking device, and door sheaves operators. A fire-rated, four-sided entrance door frame is available from The Peelle Company. A pre-engineered Wiring Package is also available; see page 7.

## Parts Availability

The Peelle Company supplies parts for doors manufactured up to 50 years ago. Parts are shipped in a quick and orderly fashion, usually within 24 hours. Parts are also available from Peelle distributors, visit [www.peelldoor.com](http://www.peelldoor.com).

## Installation Information

Installation forms available:  
(a) Guide sheet/Guide booklet  
(b) CD  
(c) Manual 215 full text - English, French or Spanish  
(d) DVD  
(e) website [www.peelldoor.com](http://www.peelldoor.com).

## Installation Tools

Installation tools for vertically sliding doors are available from our parts department, see page 7.

# CAR GATES/CAR DOORS

## OVERHEAD HEIGHT HEADROOM HEIGHT

Vertical slide-up car gates allow full access to the car opening width and height. Five types are shown below. The appropriate type depends on the overhead height/headroom height of the shaft. Vertical slide-up gates can be designed for use with most shafts, including those with limited overhead height.

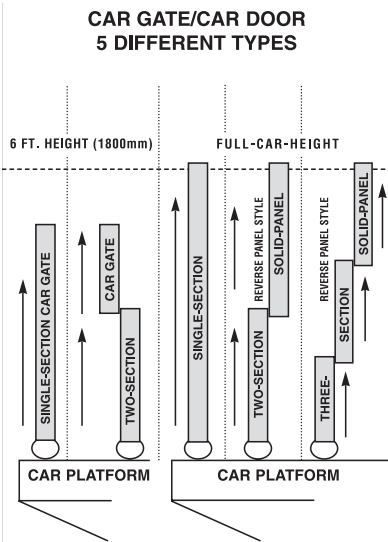

## Single-Section Car Gates/Car Doors

These are used when there is ample overhead height in the shaft. Required overhead height for 6 ft. (1800mm) high car gate, to clear the open gate, is *landing door* opening height, plus 6 ft. 1 in. (1900mm) to the nearest overhead obstruction in the shaft, measured from the top landing door sill. If landing doors have different opening heights, use largest opening height. When the car gate or car door *panel* height is more than 6 ft. (1800mm), overhead height must be increased accordingly, or use another type of car gate.

## Two-Section Car Gates/Car Doors

These are used when there is limited overhead height. Required overhead height for 6 ft. (1800mm) high two-section gate, to clear the open gate, is 1.5 times *landing door* opening height, plus 6 in. (150mm) to the nearest overhead obstruction in the shaft, measured from the top landing door sill. If landing doors have different opening heights, use largest opening height. Each of the two panel sections is a different height.

## Single-Section Car Gates/Car Doors, Solid-Panel, Full-Car-Height

Required overhead height, to clear the open gate, is 2 times *landing door* opening height, plus 2 in. (50mm) to the nearest overhead obstruction in the shaft, measured from the top landing door sill. If landing doors have different opening heights, use largest opening height.

## Two-Section Car Gates/Car Doors, Solid-Panel, Full-Car-Height

Required overhead height, to clear the open gate, is 1.5 times *landing door* opening height, plus 26 in. (650mm) to the nearest overhead obstruction in the shaft, measured from the top landing door sill. If landing doors have different opening heights, use largest opening height.

## Three-Section Car Gates/Car Doors, Solid-Panel, Full-Car-Height

Required overhead height, to clear the open gate, is 1.33 times *landing door* opening height, plus 13 in. (406mm) to the nearest overhead obstruction in the shaft, measured from the top landing door sill. If landing doors have different opening heights, use largest opening height.

## PANEL CONSTRUCTION

### Wire Mesh (3/8" / 10mm rectangular pattern) (finger resistant)

Wire mesh gate with a 0.4 in. by 2.4 in. (10mm x 60mm) rectangular pattern which will reject a 9mm ball. Gate panels are fabricated of 3/8" round wire crimped in both directions and welded into a strong channel frame. Vertical channel stiffeners are included for strength.

### Solid-Panel (Car Doors)

Car Door with 18 gauge (1.2mm) sheet steel; vision panels recommended. Usually full-car-opening-height. Required for freight-elevators-permitted-to-carry-passengers.

### Reverse Panel Style

Chains and chain hangers are out of reach from inside the car. Required for freight-elevators-permitted-to-carry-passengers.

### Height of Panels

Minimum panel height is 6 ft. (1800mm); taller panel heights are recommended. Panel heights are available from 6 ft. (1800mm) to 16 ft. (5000mm).

### Finishes/Materials

#### Plain steel car gates/car doors

- Baked on Powder Coat finish
- Plain steel car door, solid-panel, with factory-applied stainless steel fascia cover (car inside for aesthetics).

#### Stainless steel car gates/car doors

Complete Stainless with stainless rails (refer to page 8):

- Stainless steel— solid-panel type

### Panel Protection Options

A horizontal protection bumper (hardwood or channel steel) and/or a 7 gauge plate (replaceable lower two foot section) are available.

### Counterweighted

Car gates/car doors are counterweighted. Counterweights are positively guided and are guarded to prevent accidental contact.

# LANDING DOORS

## PANEL CONSTRUCTION

### Steel Plate Door F10S

This door, reinforced and welded for maximum durability, presents a flush appearance on the room side. The panels are heavy-duty 12 gauge (2.5mm) plain steel plate with strong rigid steel framing and steel reinforcing stiffening ribs every 24" / 610mm on center. The bottom edge of the upper panel has a resilient astragal. The top edge of the lower panel has a trucking sill. The doors are 1.5 hour fire-rated. Two hour fire-rated doors are available.

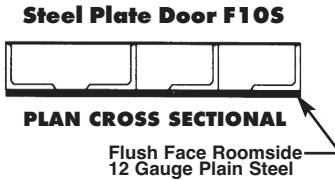

## Door Finishes/Materials

### Plain steel doors

- Baked on Powder Coat finish
- Plain steel with factory-applied stainless steel fascia cover (room side, for aesthetics). (refer to page 8)

### Stainless steel doors

- Complete Stainless Door assemblies including stainless door rails, door panels, trucking sill, and structural members (refer to page 8) – choice of IP54/NEMA 4 (moisture) or IP56/NEMA 4X (corrosion) hardware.
- Stainless panels only

## CLASS OF LOAD

For Biparting and Slide-down doors, door trucking sills are designed to match the load capacity and load classification of the elevator/lift. Following is a condensed explanation of these classifications:

**Class A: General Freight Loading.** Material is moved on and off the elevator/lift manually or by means of hand trucks only. No concentrated loading is permitted. Minimum capacity is based on 49 pounds per square foot (240 kg per square metre) of inside net platform area. Single piece loads are restricted to 25% of the rated capacity.

**Class B: Motor Vehicle Loading.** Solely for carrying automobile trucks or passenger automobiles. Minimum capacity is based on 30 pounds per square foot (145 kg per square metre) of the inside net platform area.

**Class C1: Industrial Truck Loading.** The elevator is permitted to carry a forklift along with the load. However, the total of the load and the forklift may not exceed the rated capacity of the elevator/lift.

**Class C2: Industrial Truck Loading.** For this classification, a forklift is normally not carried by the elevator but *may be used* for loading and unloading. While this classification does not affect the rated capacity, the fact that the elevator does not carry the forklift does permit exceeding the rated capacity during the loading and unloading. During elevator movement, the rated capacity may not be exceeded.

**Class C3: Other Loading With Heavy Concentrations.** (not shown) Where forklift is not normally used. Loading is determined on the basis of actual loading conditions, but not less than that required for Class A loading.

## SHAFT WALLS AND DOOR FRAMES

Freight elevator shaft walls are usually of masonry construction. Some shaft walls are drywall. Peelle offers freight elevator doors that are fire-tested and approved for installation in masonry and drywall shafts.

Freight elevator landing doors are to be installed on four-sided entrance door frames, fabricated from structured steel.

For drywall, Peelle door frames or the Peelle drywall interface kits are required. Those door frames or drywall interface kits include mounting brackets for attachment of frames to drywall. These door frames also have jamb extensions running to the beam above.

Projection sills for trucking are required for slide-up doors and are furnished by the building/general contractor.

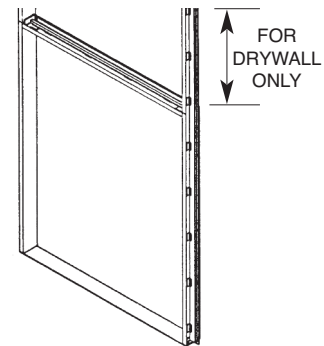

**PEELLE FOUR-SIDED ENTRANCE DOOR FRAME**  
(see page 17)

**Class A** ] [

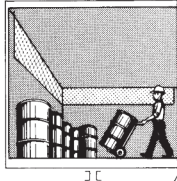

**GENERAL FREIGHT LOADING**  
WHERE NO ITEM INCLUDING  
LOADED HAND TRUCK WEIGHS  
MORE THAN 25% RATED CAPACITY

**Class B** ] [

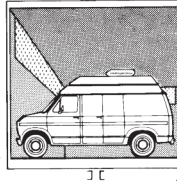

**MOTOR VEHICLE**  
AUTOMOBILES, TRUCKS,  
BUSES

**Class C1** ] [

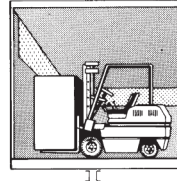

**INDUSTRIAL TRUCK LOADING**  
WHERE FORKLIFT IS CARRIED

**Class C2** ] [

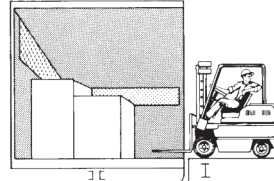

**INDUSTRIAL TRUCK LOADING**  
WHERE FORKLIFT IS NOT USUALLY  
CARRIED, BUT IS USED FOR LOADING  
AND UNLOADING

# LANDING DOORS (See DOOR/GATE TYPE CHART Page 10)

## SELECTION FACTORS

Peelle offers freight elevator doors and gates for practically any application. The size of the opening and the method of operation for the doors and gate should be determined by the size and weight of materials to be carried by the elevator/lift, as well as the method of loading and whether freight handlers or other passengers will ride on the elevator.

### Door Size

Peelle landing doors are designed to allow full access to the car opening width and height. Peelle recommends door size 8 ft. wide by 8 ft. high (2500mm by 2500mm) or larger.

### Power Operation

Power door operation is desirable for doors 8 ft. wide by 8 ft. high (2500mm by 2500mm) and larger. Power door operation is also desirable for doors in heavy traffic applications. Where door size is small and usage is infrequent, manual operation is satisfactory. Peelle manual doors are arranged for future power operation.

### Materials and Finishes

For corrosion or wet environments, stainless steel doors are available. Roomside stainless fascias are available for aesthetics. Peelle can supply stock door hardware and control room equipment suitable for most environments, such as NEMA 1 or NEMA 4.

### Door Type

Each door type has specific features to accommodate specific vertical measurements in the hoistway shaft. See chart on page 10.

### Biparting Type

Biparting doors are selected where the efficient use of hoistway space is important. The panels move in opposite directions and counterbalance each other, with the upper panel moving down and the lower panel moving up during close operation. Biparting doors do not require a sill projection.

## Hoistway Vertical Space

The type of biparting doors used depends upon the space available in the hoistway shaft. Biparting doors can be furnished for short floor heights, shallow pits or low overheads and still allow full access to the clear opening width and height of the door and car.

### Regular Biparting Doors

A Regular Door consists of an upper and a lower panel of equal height. A regular door is used when the floor-to-floor dimension equals or exceeds 1.5 times the opening height, plus 6 in. (150mm). The overhead height for the top landing door must equal or exceed 1.5 times the landing door height plus 4 in. (100mm), measured from the top landing door sill. The pit depth for the lowest landing door must equal or exceed 0.5 times the landing door height plus 6 in. (150mm), measured from the lowest landing door sill. These height and depth clearances are to be effective for the width of the opening plus the required return space on each side of the opening.

### Pass-Type Biparting Doors

Pass-Type Doors are used when the floor-to-floor dimension is less than the 1.5 times the opening height plus 6 in. (150mm) required for regular doors. The upper panel at the short height landing is offset so that when opening it slides behind the lower panel of the door at the floor above. Due to this offset, the lower panel trucking sill is wider than for a regular door.

The minimum floor-to-floor height for pass door is equal to door opening height plus 24 in. (610mm).

The pit depth and overhead height for pass doors is the same as a regular door.

### Extended Sill Biparting Doors

Extended Sill Doors are used with Pass Doors for the other floors that do not have short heights. Extended sill door has a regular door upper panel and a pass-type door lower panel.

## Telco Upper Half Biparting Doors

Telco upper half door consists of an upper panel made from two separate panels which telescope upward. It is used when the overhead is less than that required for regular or pass type doors. The minimum overhead is equal to 1.25 times landing door opening height plus 8 in. (200mm).

### Compound 2:1 Regular and Pass Biparting Doors

Compound 2:1 door consists of a lower panel that is 1/2 the height of the upper panel. It is used when the pit is less than required for regular type door. The minimum pit depth is equal to 1/3 times bottom landing door opening height plus 4 in. (100mm). Compound doors are available in both a regular type and pass type. The pass type requires the same minimum floor-to-floor height as the standard pass type biparting door.

### Slide-up/Slide-down Type

Panels on Slide-up doors move in the same direction and require a counterweight. Slide-up doors are selected when it is desirable to have all panels moving in a same direction during closing.

### Two-Section/Three-Section Slide-up Doors (Telco®)

Two-Section and Three-Section slide-up doors offer easier handling and installation than single section doors plus they require less overhead and floor-to-floor space.

### Single-Section Slide-up Doors

Used if there is enough clear vertical distance to accommodate the door between the projecting building sill and the underside of the projecting landing sill on the floor above.

### Single-Section Slide-down Type Doors

Slide-down doors are used at the top landing when there is extremely low overhead space.

# STANDARD FEATURES FOR PELLE DOORS

## POWER OR MANUAL DOORS

### 12 gauge (2.5mm) Steel Sheet Panel

F10S doors; 12 gauge; ensures a sturdy, flush face door.

### Interlocks/Retiring Cams

Doors are provided with interlocks (door locking devices) and a retiring cam (car mounted). Interlocks have durable locking arms of malleable iron. Pellee interlocks are available with UL ratings, in IP/NEMA or corresponding CSA ratings, and are certified to EN81/BS5655. Interlocks passed one million cycle tests. Door system has certificate of compliance to EC EMC directive (89/336EEC).



PELLE EN81 LABEL

### One-Piece Adjustable Guide Shoes

Replaceable, anti-friction shoes for reliable door operation.

### Resilient Astragal

A fire resistant protective cushion strip on leading edge of door panel.

### Trucking Sill

On biparting and slide-down doors, the trucking sill provides a smooth transition between the building sill and the elevator platform and supports the transferring load.

### Self-Tapping Rail Bolts

Eliminates tapping of entrance jamb. Serrated washer head. Patented.

*The dimensions are for reference only and specific job requirements may alter what is shown.*

## POWER DOORS PLC Controller Pellee Wireless Controller

Programmable Logic or Wireless Controllers easily interface with most elevator controllers. Auto-Close-System is user selectable (On/Off). Controller interface is user selectable (Standard/Slave). One controller operates front and rear same-level openings. NEMA 1 cabinet with hinged swing door (PLC only).

### Light Curtain

**Light curtain is standard.** Constantly monitors the opening for obstructions. While car gate is full open and not moving, the Light Curtain(s) protects the load handlers. No physical contact between obstruction and car gate is needed to activate Light Curtain(s). No moving parts to wear.

### Sequence Operation

During Close Operation, the car gate will be closed 2/3 or more before the landing door starts to close. Sequence Operation and the Light Curtain protect the load handlers. Once the car gate is substantially closed, then the landing door closes.

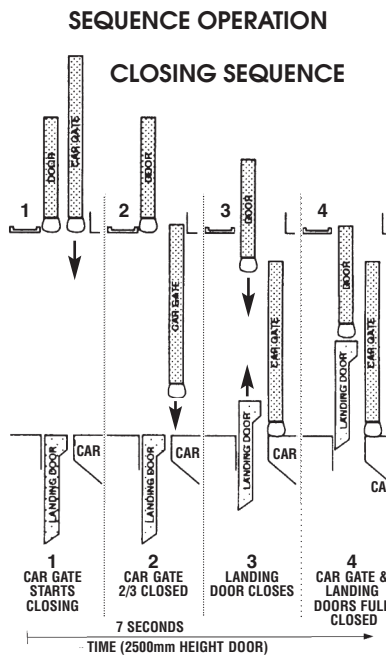

## Auto-Close-System

A standard feature. The purpose of Auto-close-system is to keep all doors normally closed, making the freight elevator available for a call from a remote floor. This is a passenger elevator feature. Door will automatically close after a pre-determined period of time or in response to remote initiation. A car-mounted warning buzzer is provided. The buzzer sounds for five seconds prior to the time the car gate starts to close, and continues to sound until the landing door is closed. Sequence Operation and Light Curtains are provided. Auto-close-system is user selectable (on/off). An optional car-mounted (strobe) warning light is available.

## Master Limit System

A standard feature. Master Limit System for each line of doors includes two proximity sensors mounted on car, which are activated by a fixed cam mounted on each door panel. Controls high/slow motor speed transitions. Controls full open and full close panel positions. Easy adjustment. No moving parts to wear. Patent #7156210B2.

## Master Limit, Landing Doors

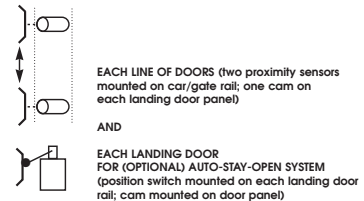

## Fire Service

Freight elevator door controllers can be provided with Fire Service operation. Fire Service auto-close is included.

## Two-Speed Operators

Each door assembly includes (2) two-speed AC operators to drive the door open and close; the door movement begins in high speed and then slow speed before final opening or closing of each door. Two-speed operation reduces wear of components while providing smooth and quiet operation.

# OPTIONAL FEATURES FOR PELLE DOORS

## POWER OR MANUAL DOORS

### Finishes

Baked on powder coat is standard; special colors/colours are available. Also available are complete stainless steel, or stainless roomside fascias.

### Stainless Steel Doors

Complete Stainless Steel doors are available for washdown/hosedown environments. Complete Stainless Steel doors include stainless rails, door panels, trucking sills, and structural members.

Choice of either:

IP54/NEMA 4 (moisture resistant) or  
IP56/NEMA 4X (corrosion resistant) hardware.  
Refer to page 8.

### Hostile Environment Equipment (UL labeled)

UL labeled hazardous location motors, interlocks, controls and limit switches are available to meet the demanding requirements of corrosive or explosive atmospheres.

NEMA	IEC	Environment
1	IP10	Normal (standard)
4	IP54/IP56	Moisture
4X	IP56	Corrosion
7,9	—	Explosion

### Side-Opposite-Locks

To ensure closed position on doors, side-opposite-locks (mechanical locks) are supplied as standard equipment on hoistway landing doors 10 ft. (3000mm) and wider, and for doors with 2 hour fire rating. Side-opposite-locks are optional on doors less than 10 ft. (3000mm) wide.

## POWER DOORS

### Transformer

Required for 3 phase AC 50/60Hz power when other than 220 volt is available.

### Pre-Engineered Wiring Material Package for wiring of doors & gates

Wire and wiring material including EMT conduit.

Junction boxes: 3 junction/pull boxes for each landing door, 2 boxes for each car gate and 1 box for top (middle) of the car.

This pre-engineered wiring system allows for fast and proper connections between equipment.

### Automatic-Stay-Open (ASO) Auto Stay Set

A feature that keeps the hoistway landing door open if rebounding occurs when loading or unloading the elevator. Damage can otherwise occur if a load strikes a partially open door. A limit switch and cam are mounted on each landing door and on each car gate. Highly recommended for Class 'B' and 'C' loading applications (automobiles, trucks, buses, forklift trucks).

## CONVENIENCE AND SAFETY KITS



### Intallation Tools Kit # 060040

The kit includes the most common Peelle props needed to simplify installation, a door dolly for moving door panels, (4) straps to properly hoist door panels, a chain break, etc. The kit is available as a parts order or for purchase with any Peelle Door System. The kit is reusable and will pay for itself on the first job.

Peelle Part #0603 Shoe Spreader / Adjuster for outward adjustment of Peelle shoes.

Peelle Part #0604 Rail Drilling Leverage Assembly

Peelle Part #0606 Door Dolly

Peelle Part #0608 Chain Pin Extractor

Peelle Part #060071 8ft Long Strap

Peelle Part #060072 10ft Long Strap

Peelle Part #060073 12ft Long Strap



### Spare Parts Kit # 060032

The Spare Parts Kit is ideal for machine rooms and service vans. The kit includes the most common Peelle parts needing service, i.e. an Unlocking Device and Keys, Door and Gate Shoes, Gate Bumpers, Springs, Chain Links, Tie Wraps, etc. The kit is available as a parts orders or for purchase with a Peelle Door system.



### Consumables Kit # 060086

The Field Consumable's Kit was developed to minimize field down time; it includes all drill bits, taps, masonry bits, grinding wheels, cut-off wheels and saw blades required to install Peelle equipment (3 hoistway doors and 1 car door per kit). Some of these items are unique to Peelle freight doors, the kit will save unnecessary installer downtime to locate these items or consume their own supplies because Peelle packaged the needed door consumables in 1 convenient kit.



### Safety Labels # 060045

The purpose of the labels is to demonstrate proper operation of vertical sliding doors. The four labels include a reminder that passengers don't ride freight elevators, how to open and close vertically sliding doors for both constant pressure close or automatic closing operation, the appropriate way to close manual doors with a web strap and how to open doors with a push plate.

# STAINLESS STEEL GUIDE

Choose the package for your application.

LANDING DOOR	<b>COMPLETE STAINLESS PACKAGE</b> IP56/NEMA 4X <i>Corrosion Resistant (Wash Down)</i>	<b>PARTIAL STAINLESS PACKAGE</b> IP54/NEMA 4 <i>Moisture Resistant (Coastal Environment)</i>	<b>FASCIA STAINLESS PACKAGE</b> IP10/NEMA 1 <i>Designed for Appearance (Public View)</i>
Door Panels	<input checked="" type="checkbox"/> Complete Stainless Panel	<input type="checkbox"/> Complete Stainless Panel <u>OR</u> <input type="checkbox"/> Plain Steel Door Panel with Stainless Steel Roomside Fascia	<input checked="" type="checkbox"/> Plain Steel Door Panel with Stainless Steel Roomside Fascia
Trucking Sill	<input checked="" type="checkbox"/> Stainless Steel	<input type="checkbox"/> Stainless <u>OR</u> <input type="checkbox"/> Plain Steel	<input checked="" type="checkbox"/> Plain Steel
Door shoes	<input checked="" type="checkbox"/> Bronze	<input checked="" type="checkbox"/> Plain Steel	<input checked="" type="checkbox"/> Plain Steel
Tension latches	<input checked="" type="checkbox"/> Bronze	<input checked="" type="checkbox"/> Bronze	<input checked="" type="checkbox"/> Plain Steel
Door rails	<input checked="" type="checkbox"/> Stainless Steel	<input checked="" type="checkbox"/> Plain Steel (recommended) <u>OR</u> <input type="checkbox"/> Stainless Steel	<input checked="" type="checkbox"/> Plain Steel
Door chains and rods	<input checked="" type="checkbox"/> Stainless Steel	<input checked="" type="checkbox"/> Stainless Steel	<input checked="" type="checkbox"/> Plain Steel
Door interlock	<input checked="" type="checkbox"/> Stainless/Bronze IP56/NEMA 4X	<input type="checkbox"/> Stainless/Bronze IP56/NEMA 4X <u>OR</u> <input type="checkbox"/> Plain Steel IP54/NEMA 4	<input checked="" type="checkbox"/> Plain Steel IP10/NEMA 1
Door operator	<input checked="" type="checkbox"/> IP56/NEMA 4X	<input checked="" type="checkbox"/> IP54/NEMA 4	<input checked="" type="checkbox"/> IP10/NEMA 1
Door gear/sheave	<input checked="" type="checkbox"/> Bronze	<input checked="" type="checkbox"/> Plain Steel	<input checked="" type="checkbox"/> Plain Steel
Door Limit (individual)	<input checked="" type="checkbox"/> Stainless IP56/NEMA 4X	<input checked="" type="checkbox"/> Plain Steel IP54/NEMA 4	<input checked="" type="checkbox"/> Plain Steel IP10/NEMA 1
<b>ENTRANCE FRAME (optional)</b>	<input type="checkbox"/> Plain Steel with Stainless Cover <u>OR</u> <input type="checkbox"/> Stainless Steel (not fire rated)	<input type="checkbox"/> Plain Steel with Stainless Cover <u>OR</u> <input type="checkbox"/> Stainless Steel (not fire rated)	<input type="checkbox"/> Plain Steel with Stainless Cover <u>OR</u> <input type="checkbox"/> Stainless Steel (not fire rated)
<b>CAR GATE/CAR DOOR</b>			
Car gate panel (s)	<input type="checkbox"/> Stainless Wire Mesh <u>OR</u> <input type="checkbox"/> Stainless Solid Panel	<input type="checkbox"/> Stainless Wire Mesh <u>OR</u> <input type="checkbox"/> Stainless Solid Panel <u>OR</u> <input type="checkbox"/> Plain Steel with Stainless Car Side Fascia	<input type="checkbox"/> Stainless Wire Mesh <u>OR</u> <input type="checkbox"/> Stainless Solid Panel <u>OR</u> <input type="checkbox"/> Plain Steel with Stainless Car Side Fascia
Gate shoes	<input checked="" type="checkbox"/> Bronze	<input checked="" type="checkbox"/> Plain Steel	<input checked="" type="checkbox"/> Plain Steel
Gate rails	<input checked="" type="checkbox"/> Stainless Steel	<input checked="" type="checkbox"/> Stainless Steel	<input type="checkbox"/> Plain Steel <u>OR</u> <input type="checkbox"/> Stainless (recommended if stainless gate or stainless car enclosure)
Gate chains	<input checked="" type="checkbox"/> Stainless Steel	<input checked="" type="checkbox"/> Stainless Steel	<input type="checkbox"/> Plain Steel <u>OR</u> <input type="checkbox"/> Stainless (recommended if stainless gate or stainless car enclosure)
Gate contact	<input checked="" type="checkbox"/> Stainless Steel IP56/NEMA 4X	<input checked="" type="checkbox"/> Plain Steel IP54/NEMA4	<input checked="" type="checkbox"/> IP10/NEMA 1
Gate operator	<input checked="" type="checkbox"/> IP56/NEMA 4X	<input checked="" type="checkbox"/> IP54/NEMA 4	<input checked="" type="checkbox"/> IP10/NEMA 1
Gate gear/sheave	<input checked="" type="checkbox"/> Bronze	<input checked="" type="checkbox"/> Plain Steel	<input checked="" type="checkbox"/> Plain Steel
Gate Limit	<input checked="" type="checkbox"/> Stainless Steel IP56/NEMA 4X	<input checked="" type="checkbox"/> Plain Steel IP54/NEMA 4	<input checked="" type="checkbox"/> Plain Steel IP10/NEMA 1
<b>RETIRING CAM</b>			
Top Assembly (operator)	<input checked="" type="checkbox"/> IP56/NEMA 4X	<input checked="" type="checkbox"/> IP54/NEMA 4	<input checked="" type="checkbox"/> IP10/NEMA 1

### Stainless Steel Applications

Breweries  
Sewage Plants  
Photo Processing Plants  
Tanneries  
Meat Packing Plants  
Water Treatments Plants

Institutional Kitchens  
Portside Facilities  
Food Processing Plants  
Chemical Plants  
Pulp & Paper Mills  
Mines

### NOTE:

Each application is unique. Discuss your job requirements with a Peelle Salesperson to specify the appropriate package.





# FREIGHT ELEVATOR DOOR & GATE SPECIFICATIONS

(GOODS LIFT DOORS) BIPARTING (ISO Type 4,5) OR SLIDE-UP (ISO Type 6)

## General (Standard Doors)

Furnish complete PEELLE vertically sliding freight elevator doors at each landing entrance and where shown on the plans and door schedule. Provide one (1) PEELLE vertical slide-up counterweighted car gate at each entrance of the car as required. Equipment shall be furnished by Peelle.

Doors and gates shall comply with the latest Code for Elevators/Lifts (A17.1, B44, EN81). Equipment shall comply with IP10/NEMA 1 specifications unless specified for special environments.

## Hoistway Landing Doors

Doors within size limitations shall bear Underwriters Laboratories, Inc. 1-1/2 hour Class "B" labels. Door panels shall be Peelle type "F10S" flush roomside design, with welded 12 gauge (2.5mm) roomside steel plate. The vertical edges of the door panel shall have shoe angles with solid precision grooved shoes, and may have one (1) vision panel per landing door assembly.

## For Biparting Landing Doors ONLY

The upper and lower panels of biparting landing doors counterbalance each other. The leading (bottom) edge of the upper panel shall be equipped with a fire resistant Peelle Resilient Astragal. The leading (upper) edge of the lower panel shall be equipped with a Peelle Truckable Sill designed to meet code (A17.1) requirements for the loading class specified. An Automatic Stay Closed (ASC) device (dual-side tension latches) shall be provided to minimize separation of the panel meeting edges when closed. A hinged fire lintel shall be provided at the top of the upper panel of each pass-type door.

## For Slide-up Landing Doors ONLY

The panels of slide-up landing doors are counterweighted with guided or boxed weights. The leading (bottom) edge of the lowest panel is equipped with a fire resistant Peelle Resilient Astragal. A projecting building sill is required for trucking.

## Rails and Hardware

Rails/guides shall be steel. Door panels shall be connected to each other or to counterweights with suitable roller chain running over grooved ball-bearing sheaves. Chains and chain rods are connected to panels with steel or malleable iron connectors. Cold rolled square chain rods shall be adjustable.

## Landing Door Interlocks (Door Locking Devices)

Each hoistway landing door assembly shall be equipped with an approved interlock. Each interlock shall bear a certifying label. A side opposite lock, a second lock per landing door, may be supplied as an option. A motor-operated retiring cam shall be provided for each line of landing

door interlocks. Retiring cams shall be mounted, on car sides, facing the interlocks. The retiring cam and interlock shall work in conjunction with the elevator control, to prevent normal operation of the elevator/lift unless all doors are closed and locked.

## Power Operation of Hoistway Landing Doors

Where power operation is specified, each door shall be electrically operated with two power door operators mounted on either side of the door assembly. Each motor shall be two-speed. Door travel shall be determined by proximity sensor actuation, motor speed controlled for consistent smooth door closing and opening, and shall be designed to ensure full opening and full closing. An Automatic Stay Open (ASO) feature, if provided, ensures that the door panels stay fully open. All operating mechanisms shall be entirely within the elevator/lift shaft. Manual operation shall be available in the event of power failure.

## Car Gates (Car Doors)

Car gates shall be counterweighted, vertical slide-up of the single-section, two-section or three-section type as specified. Gates shall be constructed of 3/8 in (10 mm) design mesh panels, with channel steel frame and channel stiffeners on vertical centers. Each gate shall have shoe angles, guide shoes, guide rails, suitable roller chains with adjustable connectors, sprockets (for manual operated gates), sheaves (for power operated gates), positively guided counterweight arranged to ensure balanced vertical motion, and an approved electric contact.

## Power Operation of Car Gates

Where power operation is specified, each gate shall be electrically operated by a power gate operator. The motor shall be two-speed. Gate travel shall be determined by proximity sensor actuation, motor speed controlled for consistent smooth closing and opening, and shall be designed to ensure full opening and full closing. A light curtain(s) and reopening device shall be provided on each car gate. The light curtain shall be a non-contact device, comprised of a through-beam infrared source and a detector, located at opposite ends of the car gate. The light curtain or reopening device shall provide coverage for most of the opening. An Automatic Stay Open (ASO) feature, if provided, ensures that the panels stay fully open. Manual operation shall be available in the event of power failure.

## PLC or Wireless Control (When Provided)

Suitable control panels shall be furnished to electrically energize door and gate

motors. Controllers shall be mounted within the machine room adjacent to the elevator/lift shaft.

Power doors and gates shall be arranged to open automatically as the elevator/lift arrives at a floor; and to close by continuous pressure push button operation or by Auto Close if activated. Door and gate shall reopen automatically if not closed to the full closed position. Where Auto-Close-System is turned on, door/gates shall close after a pre-determined period of time or in response to a remote initiation.

Power operated doors are provided with Sequence Operation between door and gate. The landing doors and car gate are timed so that, in closing, the car gate shall be closed at least two-thirds of its travel before the landing door starts to close.

Controller includes Sequence Operation and door close buzzer for top of car. Auto-Close-System is user selectable (on/off). Standard or Slave controller interface is user selectable. Easily interfaces with most elevator controllers. No proprietary service tool is required. Controller is to be completely front wired. Components are to be commercially available and recognized where possible. Controllers comply with CSA B44/ASME A17.5.

## Other Trades

Electrical supply of 220 volt, 3 phase, 50/60 Hz, shall be furnished by others to the Peelle controller for power operated doors. If necessary a transformer shall be furnished by Peelle. Each elevator shall have 10 amp service at 480 and 600 volt, or 20 amp service at 220 volt. It is recommended that a separate fused disconnect switch or circuit breaker dedicated to the door controller be provided in the machine room by others.

Wiring Material necessary for a complete operating installation shall be furnished by Peelle or by others. Wiring Material Package 3, see page 7.

Four-sided structural steel entrance door frames including sills and heads of frame shall be furnished by Peelle or by others and shall be set flush and plumb on the shaft side by others. Jambs for drywall hoistway construction shall extend from the floor to the building beams above. All frames at openings above or below shall be set in vertical alignment. UL labeled frames are required for drywall construction UL labeled doors. UL labeled door frames for masonry or drywall construction are available from The Peelle Company. See page 17.

*All illustrations and specifications are based on information in effect at the time of publication. Peelle reserves the right to change specifications or design and to discontinue items without prior notice or design.*



# TERMINOLOGY

## LANDING DOOR BIPARTING

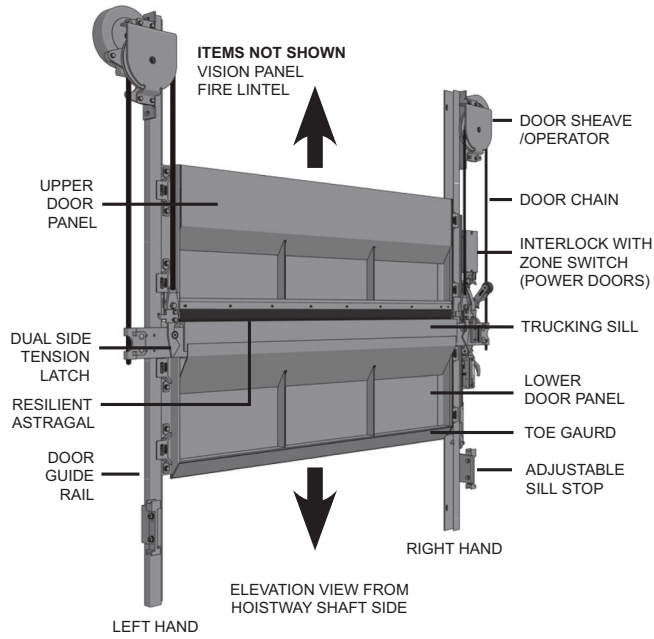

## LANDING DOOR SLIDE-UP TWO-SECTION

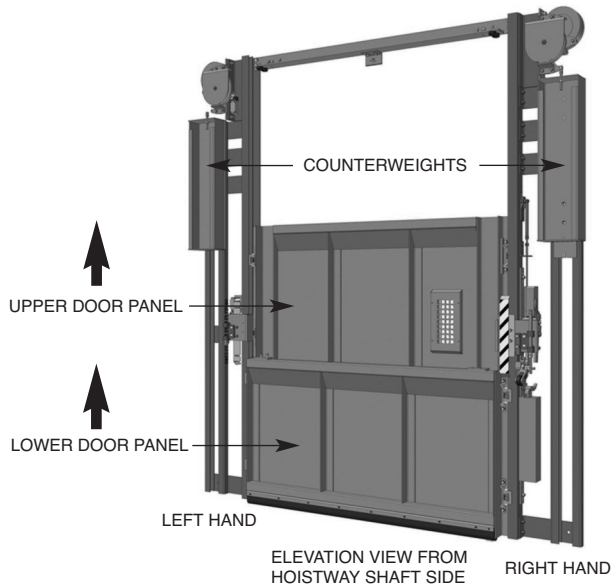

## CAR GATE WIRE MESH SINGLE-SECTION

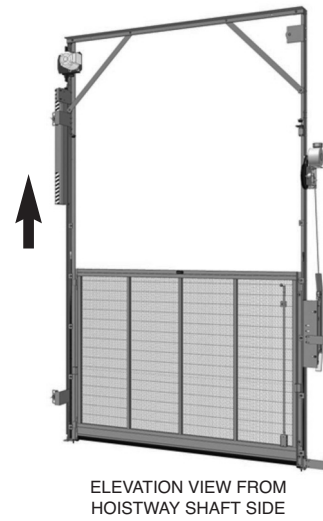

*The dimensions are for reference only and specific job requirements may alter what is shown.*

# SPACE REQUIREMENTS

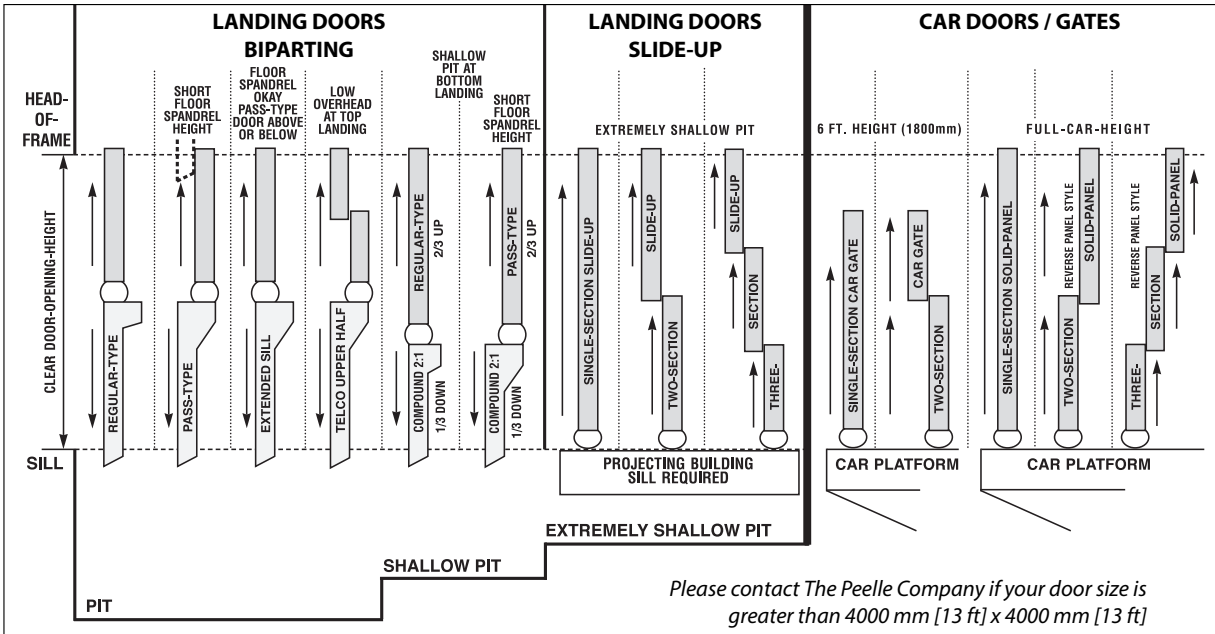

## LANDING DOORS

### REGULAR TYPE

MIN. FLOOR TO FLOOR:  $1.5 \times \text{OPENING HT} + 150 \text{ mm}$  [6 in]  
 MIN. PIT:  $0.5 \times \text{OPENING HT} + 102 \text{ mm}$  [4 in]  
 RETURN SPACE: 330 mm [13 in] BOTH SIDES  
 CAR CLEARANCE: 127 mm [5 in]

### PASS TYPE

**WHEN FLOOR TO FLOOR IS LESS THAN  $1.5 \times \text{OPENING HT} + 150 \text{ mm}$  [6 in]**  
 MIN. FLOOR TO FLOOR:  $\text{OPENING HT} + 381 \text{ mm}$  [15 in]  
 MIN. PIT:  $0.5 \times \text{OPENING HT} + 102 \text{ mm}$  [4 in]  
 RETURN SPACE: 330 mm [13 in] BOTH SIDES  
 CAR CLEARANCE: 171 mm [6 3/4 in]

### EXTENDED SILL

MIN. FLOOR TO FLOOR:  $1.5 \times \text{OPENING HT} + 150 \text{ mm}$  [6 in]  
 MIN. PIT:  $0.5 \times \text{OPENING HT} + 102 \text{ mm}$  [4 in]  
 RETURN SPACE: 330 mm [13 in] BOTH SIDES  
 CAR CLEARANCE: 171 mm [6 3/4 in]

### TELCO UPPER HALF

MIN. FLOOR TO FLOOR:  $1.25 \times \text{OPENING HT} + 330 \text{ mm}$  [13 in]  
 MIN. PIT:  $0.5 \times \text{OPENING HT} + 102 \text{ mm}$  [4 in]  
 RETURN SPACE: 330 mm [13 in] BOTH SIDES  
 CAR CLEARANCE: 171 mm [6 3/4 in]

### COMPOUND 2:1

MIN. FLOOR TO FLOOR:  $1.66 \times \text{OPENING HT} + 150 \text{ mm}$  [6 in]  
 MIN. PIT:  $0.33 \times \text{OPENING HT} + 102 \text{ mm}$  [4 in]  
 RETURN SPACE: 330 mm [13 in] BOTH SIDES  
 CAR CLEARANCE: 127 mm [5 in]  
 MAX CAR LAP: 50 mm [2 in], BEFORE NOTCHING PLATFORM

### COMPOUND 2:1 - PASS TYPE

MIN. FLOOR TO FLOOR:  $1.17 \times \text{OPENING HT} + 406 \text{ mm}$  [16 in]  
 MIN. PIT:  $0.33 \times \text{OPENING HT} + 102 \text{ mm}$  [4 in]  
 RETURN SPACE: 330 mm [13 in] BOTH SIDES  
 CAR CLEARANCE: 170 mm [6 3/4 in]  
 MAX CAR LAP: 50 mm [2 in], BEFORE NOTCHING PLATFORM

### SINGLE SECTION SLIDE-UP

MIN. FLOOR TO FLOOR:  $2 \times \text{OPENING HT} + 143 \text{ mm}$  [5 5/8 in]  
 RETURN SPACE: 457 mm [18 in] BOTH SIDES  
 CAR CLEARANCE: 171 mm [6 3/4 in]

### TWO SECTION SLIDE-UP

MIN. FLOOR TO FLOOR:  $1.5 \times \text{OPENING HT} + 279 \text{ mm}$  [11 in]  
 RETURN SPACE: 460 mm [18 in] BOTH SIDES  
 CAR CLEARANCE: 191 mm [7 1/2 in]

### THREE SECTION SLIDE-UP

MIN. FLOOR TO FLOOR:  $1.33 \times \text{OPENING HT} + 279 \text{ mm}$  [11 in]  
 RETURN SPACE: 460 mm [18 in] BOTH SIDES  
 CAR CLEARANCE: 241 mm [9 1/2 in]

## CAR DOORS / GATES

### SINGLE SECTION CAR GATE (MESH PANEL A17)

MIN. RAIL HEIGHT:  $\text{OPENING HT} + 1829 \text{ mm}$  [72 in]  
 CAR ENCLOSURE SETBACK: 114 mm [4 1/2 in]

### TWO SECTION CAR GATE (MESH PANEL A17)

MIN. RAIL HEIGHT:  $1.5 \times \text{OPENING HT} + 152 \text{ mm}$  [6 in]  
 CAR ENCLOSURE SETBACK: 165 mm [6 1/2 in]

### SINGLE SECTION SOLID PANEL (EN81)

MIN. RAIL HEIGHT:  $2 \times \text{OPENING HT} + 356 \text{ mm}$  [14 in]  
 CAR ENCLOSURE SET BACK: 165 mm [6 1/2 in]

### TWO SECTION SOLID PANEL (EN81)

MIN. RAIL HEIGHT:  $1.5 \times \text{OPENING HT} + 330 \text{ mm}$  [13 in]  
 CAR ENCLOSURE SET BACK: 191 mm [7 1/2 in]

### THREE SECTION SOLID PANEL (EN81)

MIN. RAIL HEIGHT:  $1.33 \times \text{OPENING HT} + 330 \text{ mm}$  [13 in]  
 CAR ENCLOSURE SET BACK: 229 mm [9 in]

# SPACE REQUIREMENTS

## REGULAR BIPARTING DOOR WITH SINGLE SECTION GATE

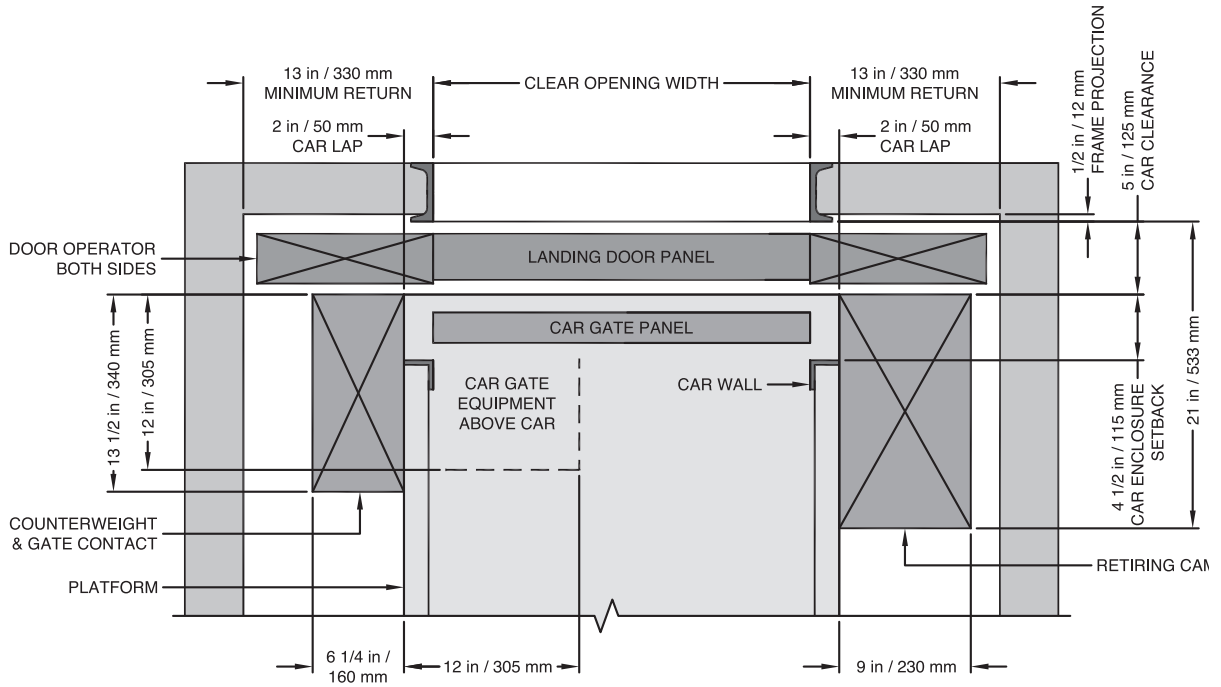

SECTIONAL PLAN VIEW

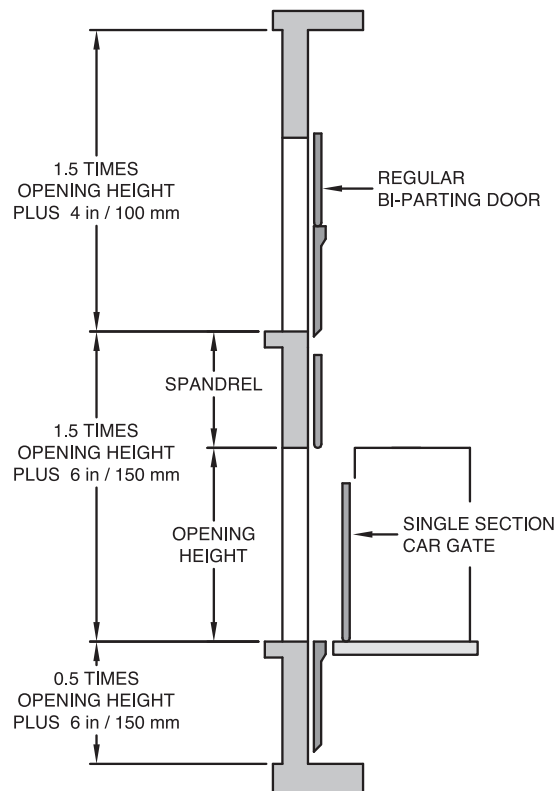

*The dimensions are for reference only and specific job requirements may alter what is shown.*

SECTIONAL ELEVATION - VERTICAL DIMENSIONS

# SPACE REQUIREMENTS

## PASS AND EXTENDED DOORS WITH DOUBLE SECTION GATE

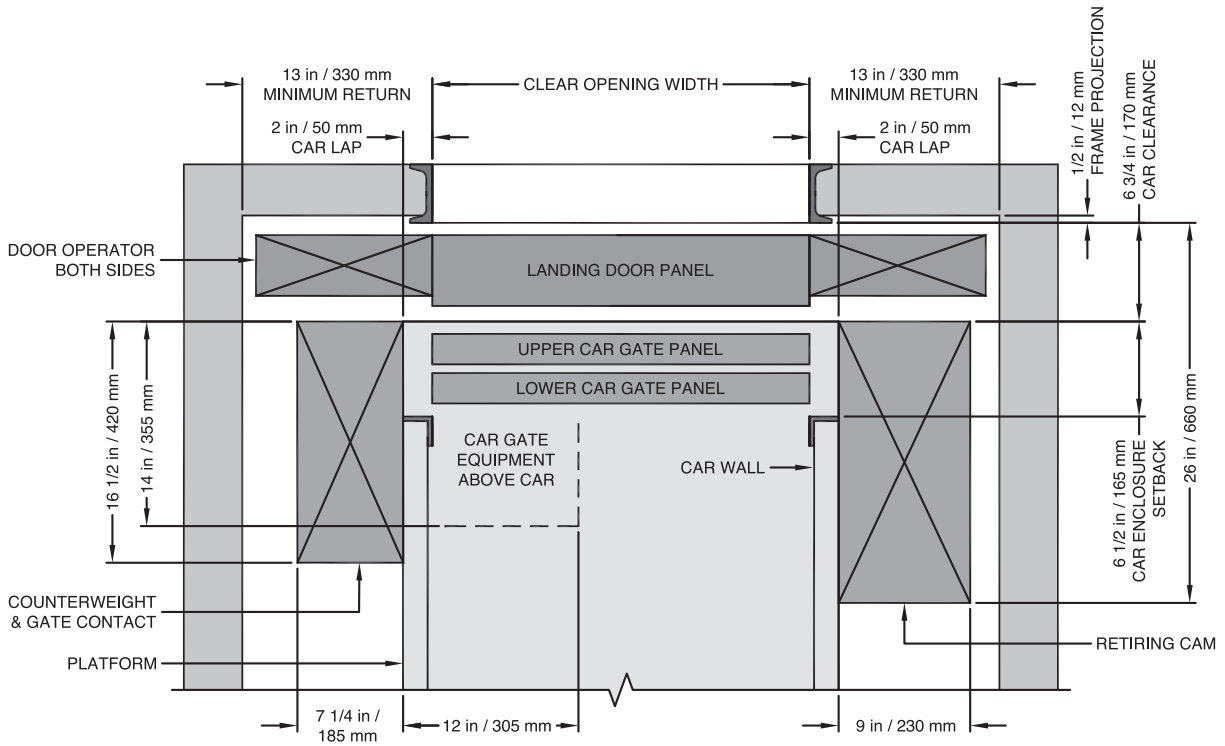

### SECTIONAL PLAN VIEW

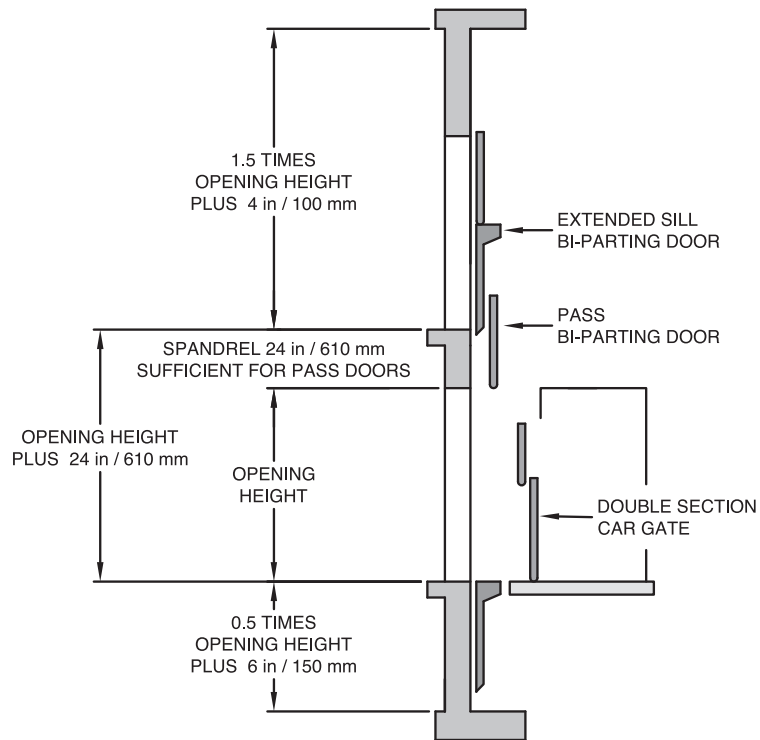

*The dimensions are for reference only and specific job requirements may alter what is shown.*

### SECTIONAL ELEVATION - VERTICAL DIMENSIONS

# SPACE REQUIREMENTS

## 1 AND 2 SECTION SLIDE UP DOORS WITH REVERSE PANEL FULL HEIGHT CAR DOOR

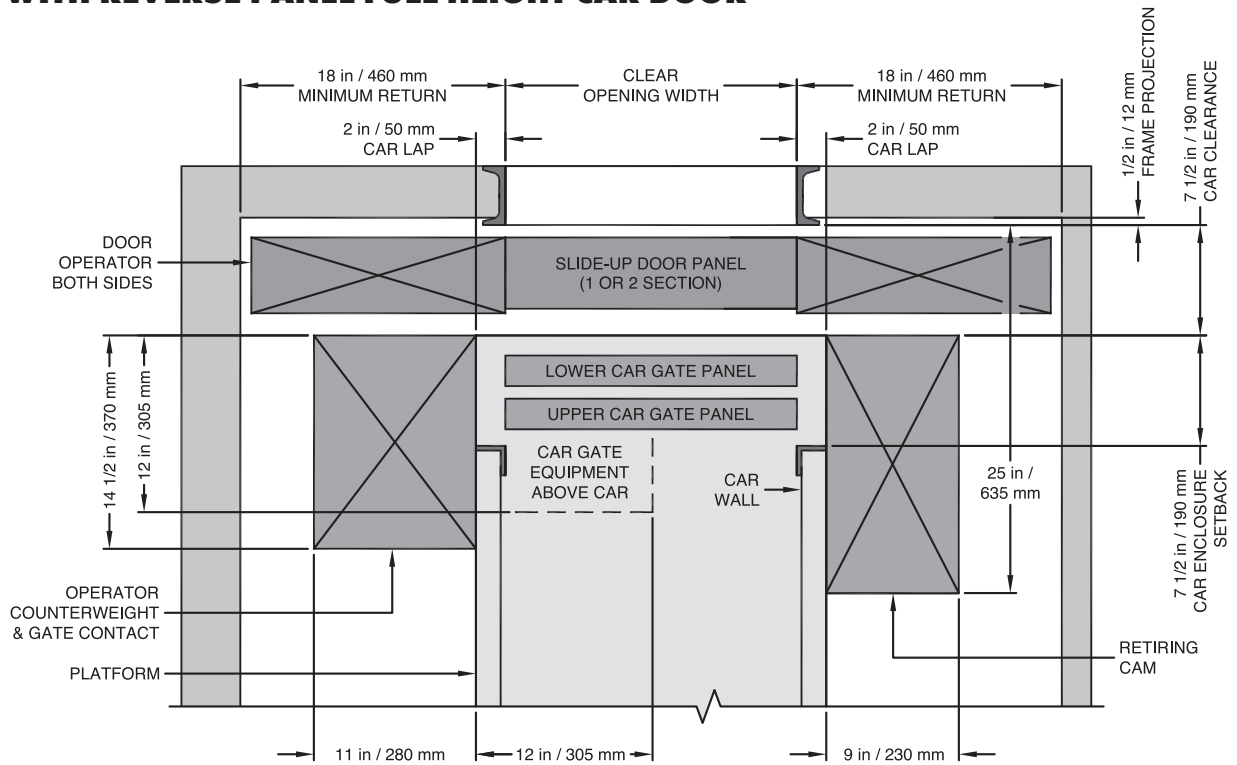

SECTIONAL PLAN VIEW

*The dimensions are for reference only and specific job requirements may alter what is shown.*

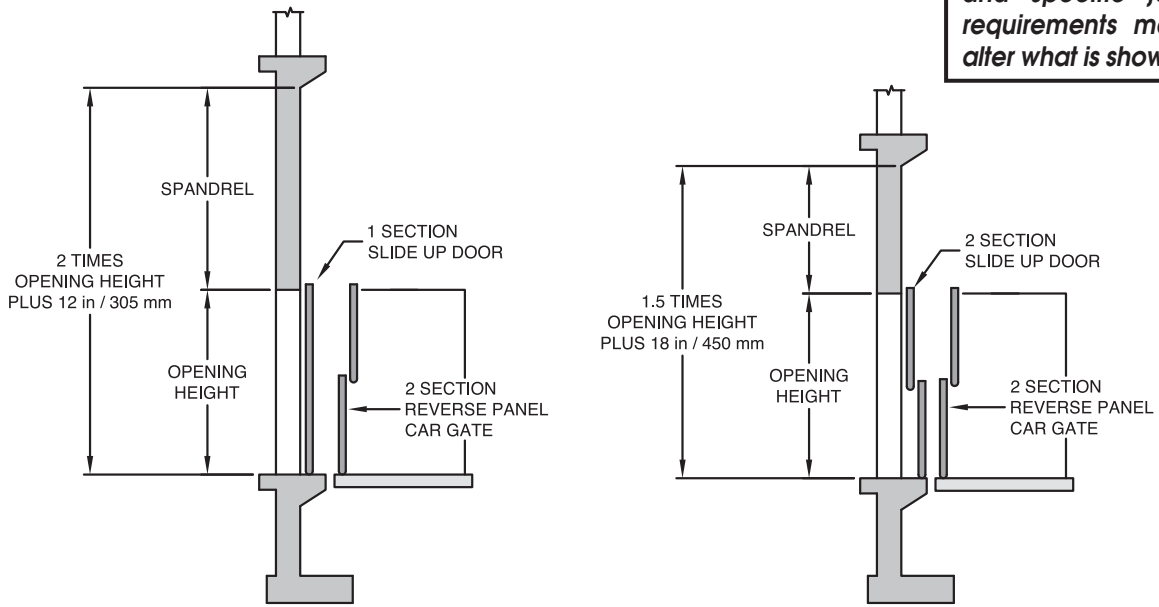

SECTIONAL ELEVATION - VERTICAL DIMENSIONS

# NEW EQUIPMENT REQUEST FOR QUOTE Page 1 of 2



The Peelle Co. Ltd.  
195 Sandalwood Pkwy. W.  
Brampton, Ontario L7A 1J6 Canada  
1-905-846-4545 • 1-800-787-5020  
**FAX: 1-905-846-2161**  
E-mail: sales@peelledoor.com

## CUSTOMER DATA

Company : \_\_\_\_\_

Address : \_\_\_\_\_

\_\_\_\_\_

\_\_\_\_\_

Contact Person: \_\_\_\_\_

Phone: \_\_\_\_\_ FAX: \_\_\_\_\_

E-mail: \_\_\_\_\_

Quote Needed By: \_\_\_\_\_

## JOB SITE DATA

Job Name: \_\_\_\_\_

Job Location: \_\_\_\_\_

\_\_\_\_\_

\_\_\_\_\_

Elevator #: \_\_\_\_\_ Building: \_\_\_\_\_

Estimated Ship Date: \_\_\_\_\_

Old Peelle Job Number: \_\_\_\_\_

*Power equipment includes Light Curtain and Sequence Operation as standard equipment.*

## GENERAL INFORMATION

Elevator Number \_\_\_\_\_

Number of Stops \_\_\_\_\_

Door Quantity - Front \_\_\_\_\_

Rear \_\_\_\_\_

Opening Width \_\_\_\_\_

Opening Height \_\_\_\_\_

Car Capacity (lbs, kg) \_\_\_\_\_

Loading Class (lbs, kg) \_\_\_\_\_

Pit Depth \_\_\_\_\_

Overhead \_\_\_\_\_

Platform Width \_\_\_\_\_

Platform Length \_\_\_\_\_

Power  Manual

Power Supply \_\_\_\_\_ V \_\_\_\_\_ Hz

(Must be 3-phase)

## LANDING DOOR DATA

Landing Door Type

Biparting

Two-Section Slide-up

Three-Section Slide-up

## CAR DOOR/GATE DATA

Car Door/Gate Type

Single-Section

Two-Section

Three-Section

## FINISH

Standard Powder Coat

Stainless Steel Fascia

Complete Stainless Steel  
(for special environment)

## APPLICABLE CODE

ASME A17

EN81

Other \_\_\_\_\_

## INSTALLATION

New Installation

Existing (replacement)

## SHAFT/HOISTWAY CONDITIONS

NEMA 1/IP10 Normal

NEMA 4/IP54, 56 Moisture

NEMA 4X/IP56 Corrosion

NEMA 7/9 Explosion

## CONTROL ROOM CONDITIONS

NEMA 1/IP10 Normal

NEMA 4/IP54, 56 Moisture

NEMA 4X/IP56 Corrosion

NEMA 7/9 Explosion

NEMA 12/IP52 Dust-Industrial

## ENTRANCE FRAMES (Complete page 16)

YES

Wall Thickness \_\_\_\_\_

## CAB ENCLOSURE (Complete page 18)

YES

## OPTIONS

Wiring Material-Package 3



**ELEVATOR & SHAFT DATA**  
FILL IN DIMENSIONS

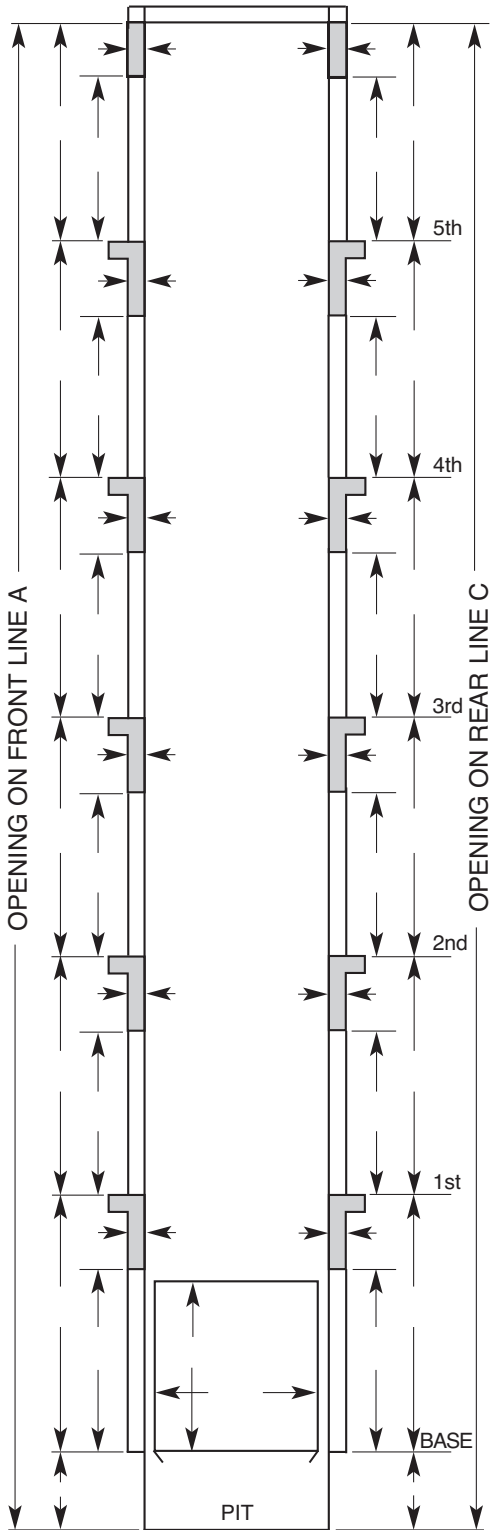

**Additional information required for existing elevator/lift and existing door rails:**

- Car Clearances from edge of car platform to building sill \_\_\_\_\_ below
- Returns (distance from *Jamb* to side walls of shaft) \_\_\_\_\_ below
- Car Laps (distance from side of car platform to entrance jambs) \_\_\_\_\_ below
- Channel Steel Door Frames existing (Yes/No) \_\_\_\_\_
- Original Peelle job number \_\_\_\_\_

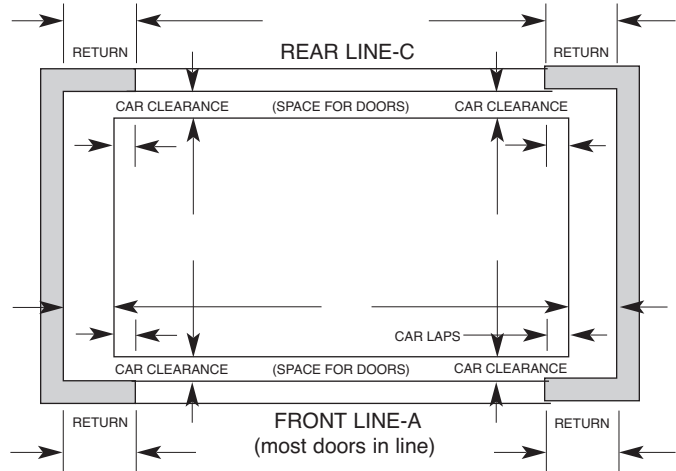

Fill in dimensions on plan view above

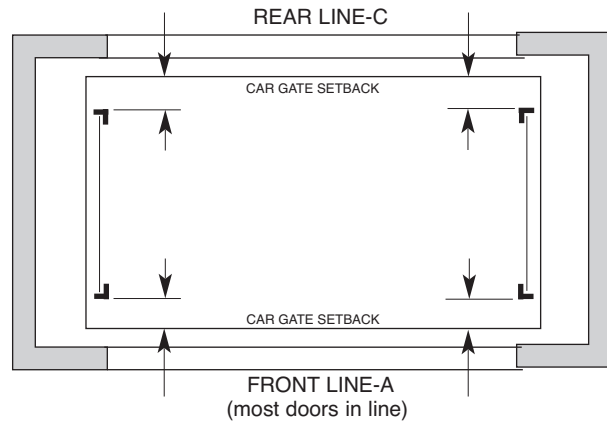

Fill in dimensions on plan view above.  
Locate landing stations on plan view above.  
Locate car operating stations on plan view above.  
Locate door vision panel preference on plan view above.  
Locate car counterweight if any on plan view above.

Use check boxes to indicate floors.

*The dimensions are for reference only and specific job requirements may alter what is shown.*



# CHANNEL ENTRANCE FRAME REQUEST FOR QUOTE Page 1 of 1

The Peelle Co. Ltd.  
 195 Sandalwood Pkwy. W.  
 Brampton, Ontario L7A 1J6 Canada  
 1-905-846-4545 • 1-800-787-5020  
**FAX: 1-905-846-2161**  
 sales@peelledoors.com

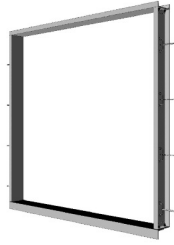

<u>Company:</u> _____	<u>Job Name:</u> _____
<u>Address:</u> _____	<u>Location:</u> _____
_____	_____
_____	_____
<u>Contact Person:</u> _____	_____
<u>Phone:</u> _____ <u>FAX:</u> _____	<u>Elevator #:</u> _____ <u>Building:</u> _____
<u>E-mail:</u> _____	<u>Estimated Ship Date:</u> _____
<u>Quote Needed By:</u> _____	<u>Old Peelle Job Number:</u> _____

Door Openings Size: Width \_\_\_\_\_ Height \_\_\_\_\_

Floor to Floor Height \_\_\_\_\_

B-1    
  1-2    
  2-3    
  3-4    
  4-5    
  5-6    
  6-7

Masonry Walls (block, brick, or poured concrete)    
  Drywall (jamb-extensions-to-beam-above will be supplied)  
 (no jamb extensions)

Wall Thickness \_\_\_\_\_ (minimum standard is 8 inch jamb for 8 in. (200mm) wall jamb for 7-5/8 in. wall)

UL "1.5 hr B" Labeled Frame

Frame Finish:  Standard Power Coat  Special Color/Colour - Powder Coat RAL # \_\_\_\_\_



# PEELLE CHANNEL ENTRANCE FRAMES

## APPLICATION:

For Peelle biparting and slide-up freight elevator landing doors. Four-sided frame.

## CHANNEL ENTRANCE FRAME

For masonry wall, frame includes:

- Welded Sill Assembly:
  - Structural Sill Angle (4 x 4 x 1/2 in. (100 by 100 by 13mm)) with anchors, welded to checker plate,
  - Checkerplate Sill (4-way medium pattern) welded to sill angle (sill width same as jamb width)
- Channel Steel Jamb (2 sides) (8 in. (200mm) or larger for masonry)
- Channel Steel Head-of-Frame (top member) (head width same as jamb width)
- Fire Rated ULC/UL "B" Label 1.5 hour (label furnished upon request)
- Baked Powder Coat Finish

Notes: Jamb may be larger than 8 in. (200mm) such as: 10 in. (250mm), 12 in. (310mm), etc.  
 Frames are shipped either before doors or with doors.  
 Frames are shipped as four separate pieces for easy handling and installation.  
 Each Entrance frame requires a lintel, above the head-of-frame, by others.

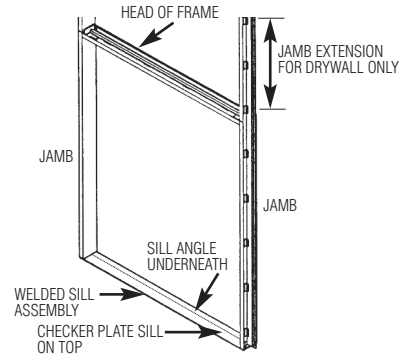

CHANNEL ENTRANCE FRAME

For drywall, frame also includes:

- Jamb-Extensions-To-Beam-Above (for strength)
- Drywall Interface Kit - mounting angles/brackets (clip angles/struts) fastened to jambs for drywall interface connection

## BENEFITS:

- Welded sill assembly for strength
- Sill mounting anchors and brackets included
- Jamb mounting anchors and brackets included
- Factory color/colour to match door panels
- Easy installation
- Coordinated engineering, shipping and finish

*The dimensions are for reference only and specific job requirements may alter what is shown.*

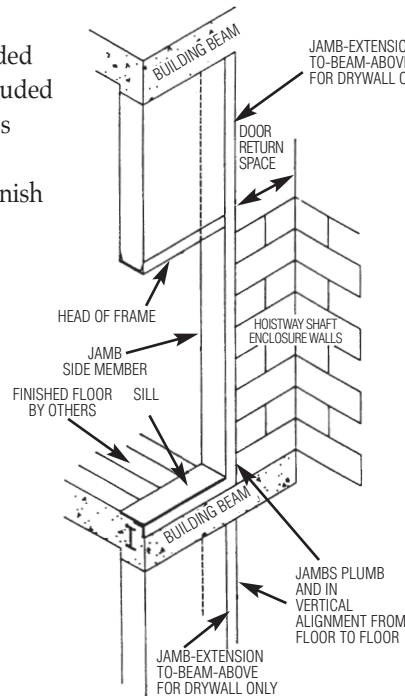

HOISTWAY SHAFT VIEW

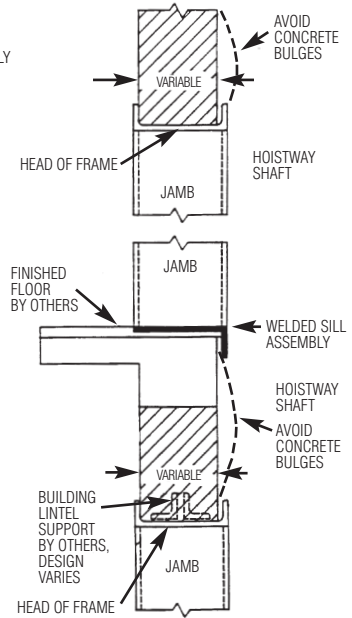

FRAME AND SILL VERTICAL CROSS SECTION THROUGH OPENING

# CAB ENCLOSURE REQUEST FOR QUOTE Page 1 of 2

The Peelle Co. Ltd.  
195 Sandalwood Pkwy. W.  
Brampton, Ontario L7A 1J6 Canada  
1-905-846-4545 • 1-800-787-5020  
**FAX: 1-905-846-2161**  
sales@peelledoor.com



Company: _____	Job Name: _____
Address: _____	Location: _____
_____	_____
_____	_____
Contact Person: _____	Elevator #: _____ Building: _____
Phone: _____ FAX: _____	Estimated Ship Date: _____
E-mail: _____	Old Peelle Job Number: _____
Quote Needed By: _____	

Opening Front       YES      

Opening At Rear \_\_\_\_\_

### Shaft/Hoistway Conditions

- NEMA 1/IP10 Normal
- NEMA 4/IP54,56 Moisture
- NEMA 4X/IP56 Corrosion
- NEMA 7/9 Explosion

### Options:

- Standard Power Coat     Special Color/Colour – Power Coat RAL # \_\_\_\_\_
- Stainless Steel Panels
- ( ) Fluorescent Light Fixtures 2-tube 1220mm /4 ft. long     LED Lighting
- Enclosure Bumper-Hardwood     Enclosure Bumper-Channel Steel     Enclosure Bumper-stainless steel
- ( ) Rows, size \_\_\_\_\_ X \_\_\_\_\_
- Enclosure Handrails (stainless)
- 2-Speed Exhaust Fan with grill                       Elevator Pads and Hooks



# CAB ENCLOSURE REQUEST FOR QUOTE

Page 2 of 2

## CAB ENCLOSURE

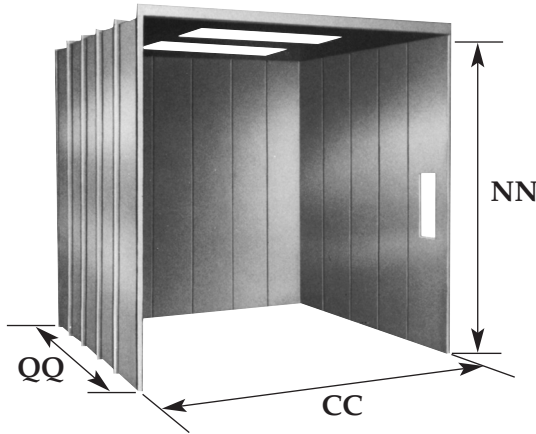

## PLATFORM SECTIONAL PLAN VIEW

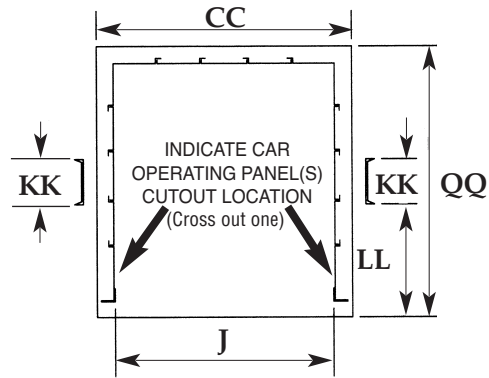

- CC. Car Platform Width \_\_\_\_\_
- QQ. Car Platform Depth \_\_\_\_\_
- NN. Car Opening Height \_\_\_\_\_
- J. Inside Cab Dimension \_\_\_\_\_
- LL. Front of Car to Stile \_\_\_\_\_
- KK. Size of Car Stile \_\_\_\_\_
- M. Cab Enclosure Angle Setback \_\_\_\_\_ below
- Door Opening Size: Width \_\_\_\_\_ Height \_\_\_\_\_
- Car Gate/Door Size: Width \_\_\_\_\_ Height \_\_\_\_\_
- Single-Section \_\_\_\_\_ Two-Section \_\_\_\_\_
- Two-Section (Solid Panel) Full-Car-Height Car Door \_\_\_\_\_
- Three-Section (Solid Panel) Full-Car-Height Car Door \_\_\_\_\_

### CAB ENCLOSURE INCLUDES:

- Side Panels of #14/2mm Gauge Construction
- Top Panels – heavy duty design
- Flush mounted Fluorescent Light Fixtures (or other)
- Hinged Emergency Exit Panel with Electric Contact
- Car Operating Station (COP) Cutouts
- Stile Mounting Brackets
- Car-to-Frame Anti-Sway Stabilizers
- Baked on Powder Coat Finish
- Mounting Carriage Bolts (one size diameter, two different lengths)

## CAR OPERATING PANEL LOCATION

### SIDE ELEVATION

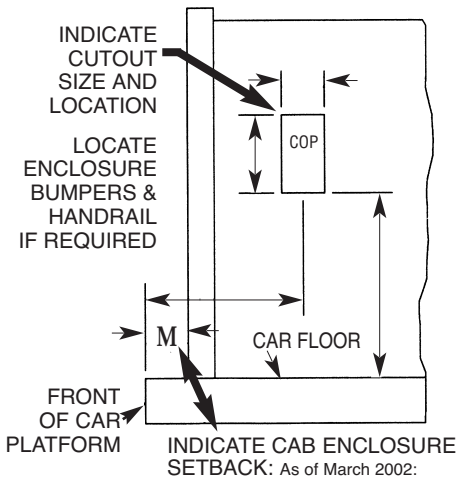

4.5 in. (115mm) single-section Peelle car gate, or  
 6.5 in. (165mm) two-section Peelle car gate, or  
 7.5 in. (190mm) two-section full-car-height Peelle car door, or  
 9 in. (216mm) three-section full-car height Peelle car door.

## Peelle Cab Enclosure Specifications

**General:** Furnish a complete PEELE cab enclosure as shown on the plans. The enclosure shall have a clear opening width of \_\_\_\_\_, a clear depth of \_\_\_\_\_, and a clear height of \_\_\_\_\_. The cab enclosure shall comply with the latest Code for Elevators/Lifts (A17.1, B44, EN81). Equipment shall comply with IP10/NEMA 1 specifications unless specified for special environments.

**Cab Enclosure Construction:** The cab side walls shall be of not less than 14 gauge (2mm) sheet steel, properly braced and reinforced. It shall be practically flush on the inside, securely and rigidly fastened. The cab top shall be of not less than 14 gauge (2mm) sheet steel, so designed as to be capable of sustaining a load of 300 lbs. on any 2 ft. square (135kg on any 0.36m square) area. A hinged emergency exit with an emergency exit contact shall be provided in the cab top. The car top shall receive a Powder Coat white finish. If bumpers are supplied, cab enclosures in excess of 10 ft. (3000mm) in width or height shall be constructed with additional support.

**Lighting:** Light fixtures 2-tube fluorescent 4 ft. (1220mm) long shall be provided, as required. Recessed light fixtures shall be practically flush with the cab top interior. At least two light fixtures are recommended for car platform *depths* greater than 8 ft. (2500mm); one light fixture for every 4 ft. (1220mm) of depth. Two in-line light fixtures per door line are recommended for car platform *widths* greater than 8 ft. (2500mm) For example, a 10 ft. (3000mm) *wide* by 10 ft. (3000mm) *deep* car platform should have 4 light fixtures. At least two lights, one near front and one near rear, are recommended for cars with front and rear openings. Other lighting options are available.

**Fixture Cutouts:** All required cab enclosure fixture cutouts shall be provided by Peelle. Cutouts shall have perimeter steel angles for added strength. Fixtures shall be furnished by others.

**Finish:** Enclosure panels shall be given one coat of baked-on powder coat finish.

**Car Gate/Car Door Mounting:** Cab enclosure shall be arranged for mounting of Peelle car gates/car doors.



Phone +1 905 846 4545

Toll Free +1 800 787 5020

Fax +1 905 846 2161

[sales@peelledoor.com](mailto:sales@peelledoor.com)

[www.peelledoor.com](http://www.peelledoor.com)